

NNOVA MICRO

**1023 ARIA_CONTROLLORE PER
STUFA A PELLETTA CANALIZZATA
1023 AIR_CONTROL BOARD FOR
PELLET STOVE WITH DUCTWORK**

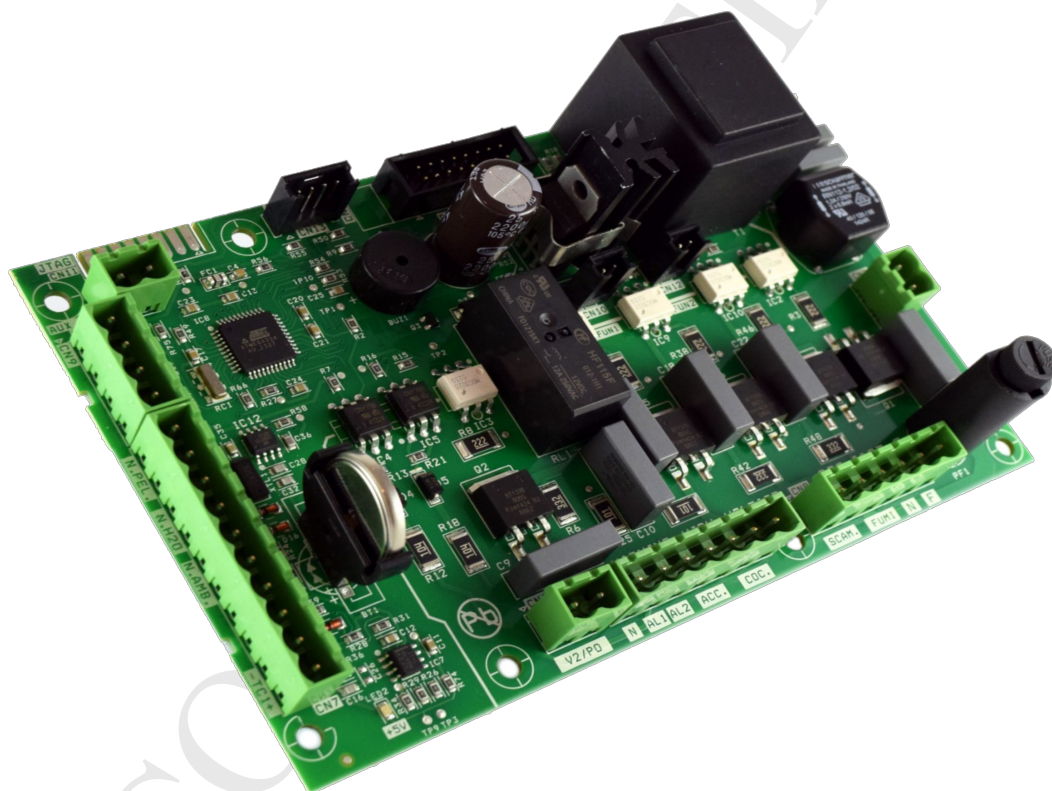

**MANUALE TECNICO
PER L'INSTALLATORE
TECHNICAL INSTALLATION
MANUAL**



INDEX

1. PREFACE	7
2. REVISIONS	7
3. INTRODUCTION	7
3.1 Abbreviations	7
3.2 Scope	7
3.3 General description	7
3.4 Accessories	9
3.5 Regulations	9
4. TECHNICAL SPECIFICATION	9
4.1 Electrical specifications	9
4.2 Environmental specifications	11
4.3 Mechanical specifications	11
4.4 Connections	11
5. INSTALLATION	13
5.1 Automated system test	13
5.2 Starting your pellet stove	15
6. USER INTERFACE	15
6.1 Description of the console	17
6.2 What are the buttons for	19
7. MENU	21
7.1 User menu	21
7.2 Menu 01 - fan regulation	25
7.3 Menu 02 - set clock	25
7.4 Menu 03 - set timer program	27
7.5 Menu 04 - language selection	33
7.6 Menu 05 - standby mode	33
7.7 Menu 06 - alarm mode	33
7.8 Menu 07 - initial charging	35
7.9 Menu 08 - stove status	35
8. OPERATING MODE (USER)	37
8.1 Lighting the stove	37
8.2 Lighting phase	37
8.3 Transition from off to working	39
8.4 Lighting failure	41
8.5 Working mode	41
8.6 Adjusting the room temperature setting	41
8.7 How to use the external thermostat/programmable thermostat	41
8.8 Room temperature reaches the set temperature	43
8.9 Clearing the ashpan	43
8.10 Switching off the stove	45
8.11 Stove in off mode	45
8.12 Reigniting the stove	45
9. WHAT HAPPENS IF	47
9.1 The pellet does not turn on	47
9.2 There is a power outage (black out)	47

INDEX continued

10.ALARMS	49
10.1 Flue gas temperature probe alarm	49
10.2 Flue gas over-temperature alarm	49
10.3 Ignition failure alarm	51
10.4 Shut down during working mode alarm	51
10.5 Pressure switch for auger safety alarm	51
10.6 General thermostat alarm	53
10.7 Exhaust malfunction alarm	53
11.OPERATING MODE (TECHNICAL MENU)	55
11.1 Submenu 09 - 01 - 01 load pellet	59
11.2 Submenu 09 - 02 - 01 chimney type	59
11.3 Submenu 09 - 03 databases	59
11.4 Submenu 09 - 04 channel data	59
11.5 Submenu 09 - 05 various adjustments	59
11.6 Submenu 09 - 06 output test	61
11.7 Submenu 09 - 07 factory settings	61
11.8 Submenu 09 - 08 reset partial hours	61
11.9 Submenu 09 - 09 reset alarms	61
11.10 Submenu 09 - 10 meter memory	61
11.11 Flue probe reset	63
11.12 Control board memory structure	65
11.13 Creating personalized databases	67
12.CONTROL BOARD FIRMWARE UPDATE	69
APPENDIX A (Parameter table)	71
APPENDIX B (Start up sequence and working conditions)	77
APPENDIX C (Usage parameters)	81

Micronova	Control board I023	date 20/05/2016 page 7 of 83
------------------	---------------------------	---------------------------------

1. PREFACE

version	date	project code	written by
1.0	26.11.2007	I023	Alberto Ferrario

2. REVISIONS

version	date	previous revision	description of the changes	written by
1.1	28.05.2008	1.0	Corrected auger period hour = 4s	Alberto Ferrario
1.2	16.05.2008	1.1	Corrected unit of measurement Pr44 in Appendix A - Updated cover image	Alberto Ferrario
1.3	20.05.2016	1.2	1 All images have been updated 2 English translation of manual has been added	Nicola Cabbia

3. INTRODUCTION

3.1 Abbreviations

The following abbreviations are used:

BI .PEL	Fire door
Accend.	Glow plug
C. Risc.	Heating pump
C. San.	Sanitary pump
ALF	General safety thermostat
ALF	Auger safety thermostat
EEPROM	Electrically Erasable Programmable Read Only Memory

3.2 Scope

The present document describes the **I023** control board. This device was specifically made for usage in air pellet stoves. It manages all of the stove's functions through an adequate number of inputs and outputs.

3.3 General description

The control board is made up of a circuit board equipped with a series of connectors that allow the circuit board to connect to the various devices, which include the following:

- the *console* (or control panel) of which several versions have been produced and which is highly personalizable.
- Sensors (temperature, etc.).
- Fans.
- Auger.
- Glow plug.
- Alarms.
- ICommunication interfaces (RS232, Bluetooth, ecc.).

3.4 Accessories

The device can include:

- Weekly programmable thermostat
- IR remote (through the *console*)
- Standard self-extinguishing ABS container UL 94 V0
- LCD *Console*

3.5 Regulations

The device is manufactured according to the following standards:

- EN 55011
- EN 61000-3-2
- IEC/EN 61000-4-2, -4, -5, -6, -8, -9, -11, -29

4. TECHNICAL SPECIFICATIONS

Here, as follows, is a list of the device specifications. Please refer to *figure 1* for an illustration of the circuit's electrical connections.

4.1 Electrical specifications

Power source

Supply voltage	230V _{ac} ± 15%, 50/60 Hz
Max consumption (excluding console and users)	50 mA
Max consumption (console connected excl. users)	55 mA

Inputs

Flue temperature thermocouple	Thermocouple type J
External thermostat	Contact n.o.
Room temperature NTC probe	NTC 10 kΩ
Water temperature NTC probe	NTC 10 kΩ
Pellet temperature NTC probe	NTC 10 kΩ
Console	-
Fume extractor rotation speed encoder	-
Optional programmable thermostat control board	-
General safety thermostat	230V _{ac}
Safety pressure switch	230V _{ac}
Serial connection (to be used with an adaptor)	-

Outputs

Fume exhaust (with phase control regulation)	230 V _{ac} (TRIAC)
Exchanger fan no.1 (with phase control regulation)	230 V _{ac} (TRIAC)
Exchanger fan no.2 (with phase control regulation)	230 V _{ac} (TRIAC)
Exchanger fan no.3 (with phase control regulation)	230 V _{ac} (TRIAC)
Auger motor	230 V _{ac} (TRIAC)
Glow plug	230 V _{ac} (Contact)

The following table demonstrates in detail the available connectors and the relative pinout and functional descriptions.

<i>connector</i>	<i>pin</i>	<i>label</i>	<i>description</i>
CN1	-	-	Quick connect ground terminal
CN2	1 - 2	AUX	Air fan output no.2
CN4	1	N	Neutral
	2	AL1	Security temperature sensor alarm input (230 V _{ac})
	3	AL2	Security pressure switch alarm input (230V _{ac})
	4 - 5	ACC	Glow plug output (230V _{ac})
	6 - 7	COC	Auger motor output (230V _{ac})
CN5	-	DISPLAY	Console connector
CN6	1-2	V2/PO	Air fan output no.3 (circulator)
CN7	1 - 2	N. PEL	Air/pellet temperature probe input (not used)
	3 - 4	N. H20	Water temperature probe input (not used)
	5 - 6	N. AMB	Room temperature probe input
	7 - 8	TERM	External thermostat input
	9 - 10	-TC+	Flue thermocouple input
CN8	1 - 2	SCAM	Exchanger fan output no.1
	3 - 4	FUMI	Flue fan output
	5 - 6	N - F	Control board power (230V _{ac})
CN9	1	ENC	Flue fan encoder input
	3	+5V	Encoder power (+ 5V _{dc})
	4	GND	Encoder common input
	5	BLUE	Not used
CN12	-	JTAG	Factory programming connector
CN13	-	SERIALE	Serial connection to be used with adaptor
CN15	1 - 2	AUX IN	Auxiliary input

5. INSTALLATION

Install the circuit board inside the stove in such a position that will prohibit it from exceeding the operational temperature specifically indicated. The cables and clips provided are sufficient enough to guarantee the correct wiring of the connections to all the various elements of the electrical circuit. Please refer to *figure 1* for more details.

5.1 Automated system test

Micronova provides an automated end-of-production-line testing system that allows for the necessary verifications to assure the correct assembly of the circuit board and the various external parts (probes, motors, etc.).

5.2 Starting your pellet stove

Once you are certain to have correctly followed the installation instructions, you can start your pellet stove for the first time. This includes all of the parameter setting steps. These can be set through the use of the buttons on the console or, more quickly and more safely, through the use of a personal computer and the interface software, as well as through the use of the programming system that can be provided by Micronova. By using the automated testing system, this operation is completely automatic and included in the various phases of the final test of the device.

6. USER INTERFACE

Through the *console* you can have a dialogue with the control board simply by pressing a few buttons. The display informs the operator on the working status of the stove. In programming mode the various settings can be visualized and modified through the use of the buttons.

Both the appearance of the display panel and the silk screen print are customizable by the client.

The information available in the present manual refers to the control board equipped with the programmable thermostat option.

6.1 Console

The *console* displays information on the working status of the stove. By accessing the menu you can gain access to different views and change the various available settings based on the access level.

Depending on the operating mode, the various positions on the display can gain different meanings.

Figure 2 is an example of the display when the stove is either on or off.

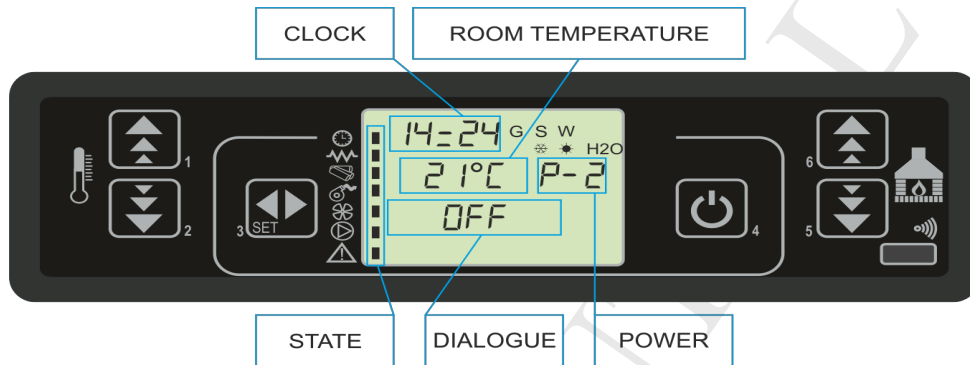

fig.2

Figure 3 demonstrates the meanings of the status symbols on the left of the display.

The activation of one of the symbols in the “status” area on the display indicates the activation of the corresponding device according to the list.



fig.3

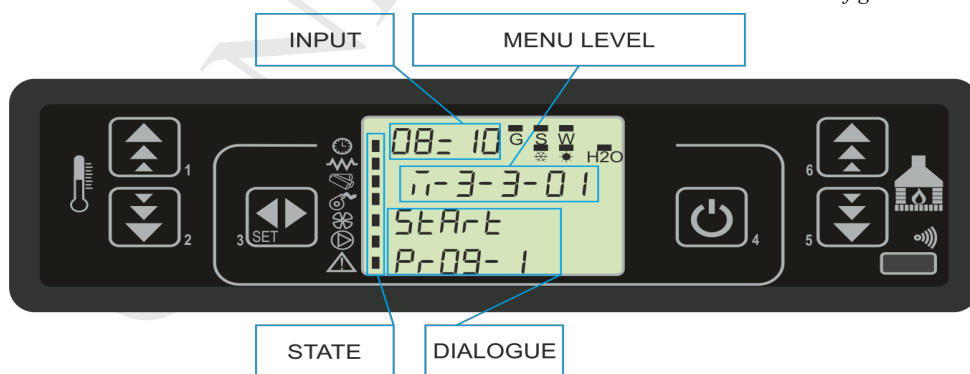

fig.4

Figure 4 depicts the layout of the messages in the programming or setting phase. Particularly:

1. The *input* section displays the chosen settings.
2. The *menu level* section displays the current menu level. See the chapter about the menu.

Micronova	Control board I023	date 20/05/2016 page 19 of 83
------------------	---------------------------	----------------------------------

6.2 What are the buttons for?

<i>button</i>	<i>description</i>	<i>mode</i>	<i>action</i>
1	Increase temperature	PROGRAMMING	Adjust/increase the value in the selected menu
		ON/OFF	Increase the temperature value of the room thermostat
2	Decrease temperature	PROGRAMMING	Adjust/decrease the value in the selected menu
		ON/OFF	Decrease the temperature value of the room thermostat
3	Menu	-	Accesses the menu
		MENU	Accesses the submenu level
		PROGRAMMING	Sets the value and moves to the next menu
4	ON/OFF unlock	ON	Hold for 2 seconds to switch the stove on when in off mode, or off when in on mode
		LOCK	Unlocks the stove and puts it into off mode
		MENU/ PROGRAMMING	Brings you to the next menu level, any adjustments made will be saved
5	Decrease power	ON/OFF	Adjust the power produced by the stove
		MENU	Takes you to the next menu level
		PROGRAMMING	Takes you to the next submenu, any adjustments made will be saved
6	Increase power	ON/OFF	Adjust the speed of the exchanger
		MENU	Takes you back to the previous menu level
		PROGRAMMING	Takes you to the previous submenu, any adjustments made will be saved

7. MENU

You can gain access to the menu by pressing the P3 (MENU) button.

It is divided into various items and levels that allow you to access the settings and circuit board programming.

The items on the menu that allow you to access the technical programming are passcode protected.

7.1 User menu

The following table briefly describes the menu structure. This paragraph focuses specifically on the settings available to the user.

Menu item 01-regulate fans is available only if the corresponding function has been activated (see technical settings).

<i>level 1</i>	<i>level 2</i>	<i>level 3</i>	<i>level 4</i>	<i>value</i>
01 - regulate fans				select value
02 - set clock				
	01 - day			day of week
	02 - hours			hour
	03 - minutes			minute
	04 - day			day of month
	05 - month			month
	06 - year			year
03 - set timer				
	01 - enable timer			
		01 - enable timer		on/off
	02 - day program			
		01 - daily timer		on/off
		02 - start day 1		time
		03 - stop day 1		time
		04 - start day 2		time
		05 - stop day 2		time
	03 - week program			
		01 - weekly time		on/off
		02 - start prog 1		time
		03 - stop prog 1		time
		04 - monday prog 1		on/off
		05 - tuesday prog 1		on/off
		06 - wednesday prog 1		on/off
		07 - thursday prog 1		on/off
		08 - friday prog 1		on/off
		09 - saturday prog 1		on/off

<i>level 1</i>	<i>level 2</i>	<i>level 3</i>	<i>level 4</i>	<i>VALUE</i>
		10 - sunday prog 1		on/off
		11 - start prog 2		time
		12 - stop prog 2		time
		13 - monday prog 2		on/off
		14 - tuesday prog 2		on/off
		15 - wednesday prog 2		on/off
		16 - thursday prog 2		on/off
		17 - friday prog 2		on/off
		18 - saturday prog 2		on/off
		19 - sunday prog 2		on/off
		20 - start prog 3		time
		21 - stop prog 3		time
		22 - monday prog 3		on/off
		23 - tuesday prog 3		on/off
		24 - wednesday prog 3		on/off
		25 - thursday prog 3		on/off
		26 - friday prog 3		on/off
		27 - saturday prog 3		on/off
		28 - sunday prog 3		on/off
		29 - start prog 2		time
		30 - stop prog 2		time
		31 - monday prog 2		on/off
		32 - tuesday prog 2		on/off
		33 - wednesday prog 2		on/off
		34 - thursday prog 2		on/off
		35 - friday prog 2		on/off
		36 - saturday prog 2		on/off
		37 - sunday prog 2		on/off
	04 - week-end program			
		01 - week-end timer		
		02 - start 1		
		03 - stop 1		
		04 - start 2		
		05 - stop 2		
04 - language select.				
	01 - Italian			set
	02 - French			set
	03 - English			set

Micronova	Control board I023	date 20/05/2016 page 25 of 83		
<i>level 1</i>	<i>level 2</i>	<i>level 3</i>	<i>level 4</i>	<i>value</i>
	04 - German			set
05 - stand-by mode				on/off
06 - buzzer				on/off
07 - initial charge				set
08 - stove status				-

7.2 Menu 01 - fan regulation

It allows for the independent regulation of the two supplemental fans.

For each of the two fans the following choices are available (as demonstrated in the table below). Press the P1 (fan 2) and P2 (fan 3) buttons to select.

<i>settings</i>	<i>fan 2</i>	<i>fan 3</i>
A	corresponding to the selected power	corresponding to the selected power
0	fan off	fan off
1	fixed speed Pr57	fixed speed Pr62
2	fixed speed Pr58	fixed speed Pr63
3	fixed speed Pr59	fixed speed Pr64
4	fixed speed Pr60	fixed speed Pr65
5	fixed speed Pr61	fixed speed Pr66

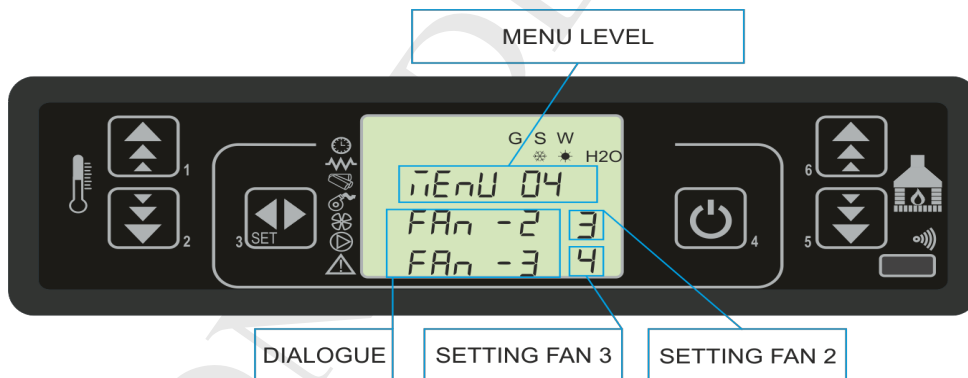

7.3 Menu 02 - set clock

Sets the current time and date. The circuit board comes equipped with a lithium battery that allows the internal clock to have an autonomy of over 3/5 years.

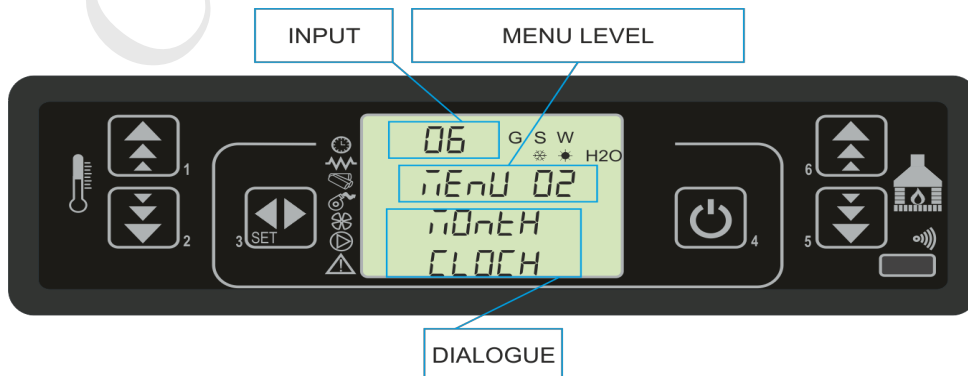

7.4 Menu 03 - set timer

Submenu 03 - 01 - enable timer

It allows you to globally enable and disable all of the functions of the programmable thermostat.

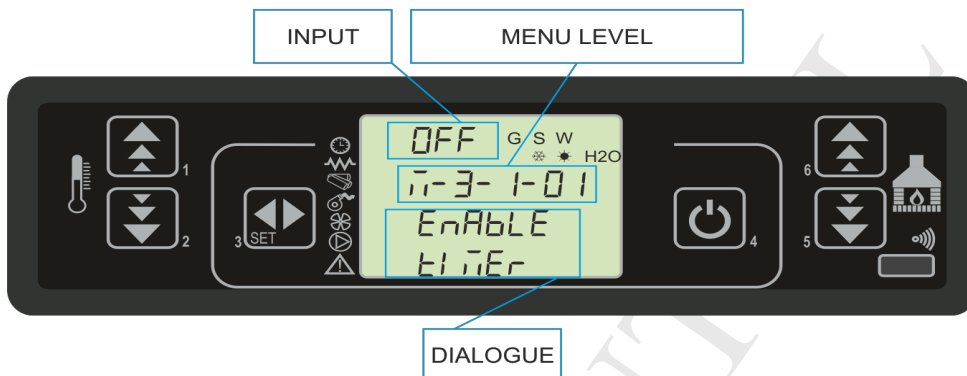

Submenu 03 - 02 - daily program

It allows you to enable, disable and set the functions of the daily thermostat program.

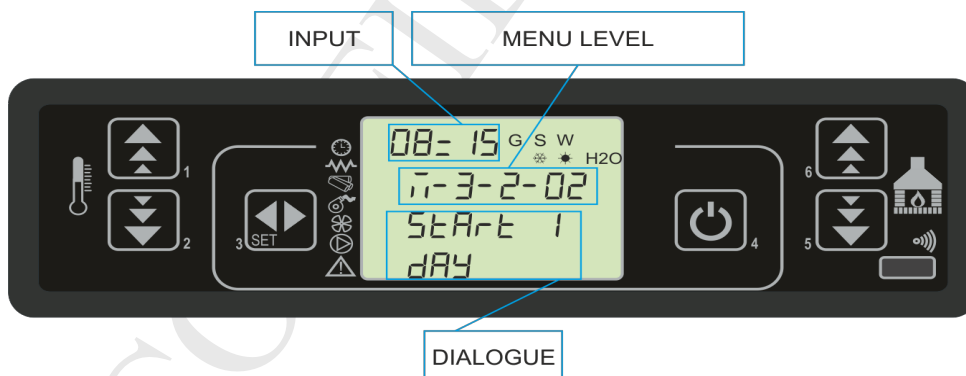

It is possible to set two different functions delimited by set times as the following table demonstrates. In the table, OFF directs the clock to ignore the command:

<i>selection</i>	<i>meaning</i>	<i>possible values</i>
START 1	activation time	time - OFF
STOP 1	deactivation time	time - OFF
START 2	activation time	time - OFF
STOP 2	deactivation time	time - OFF

Submenu 03 - 03 - weekly program

It allows you to enable, disable and set the functions of the weekly thermostat program.

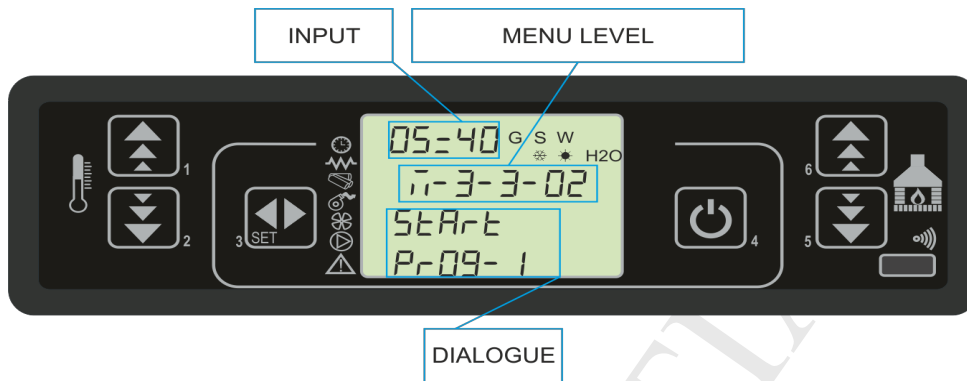

The weekly programmer has 4 independent programs and the weekly program is made up of a combination of these four single programs.

The weekly programmer can be activated or deactivated.

Furthermore, the clock will ignore the corresponding program when OFF is set in the time section.

Caution: carefully select the programming and avoid allowing the activation times and/or deactivation times to overlap on the same day in different programs.

<i>PROGRAM 1</i>			
<i>menu level</i>	<i>selection</i>	<i>meaning</i>	<i>possible values</i>
03-03-02	START PROG 1	activation time	time - OFF
03-03-03	STOP PROG 1	deactivation time	time - OFF
03-03-04	MONDAY PROG 1	day of reference	on/off
03-03-05	TUESDAY PROG 1		on/off
03-03-06	WEDNESDAY PROG 1		on/off
03-03-07	THURSDAY PROG 1		on/off
03-03-08	FRIDAY PROG 1		on/off
03-03-09	SATURDAY PROG 1		on/off
03-03-10	SUNDAY PROG 1		on/off

PROGRAM 2			
<i>menu level</i>	<i>selection</i>	<i>meaning</i>	<i>possible values</i>
03-03-11	START PROG 2	activation time	time - OFF
03-03-12	STOP PROG 2	deactivation time	time - OFF
03-03-13	MONDAY PROG 2	day of reference	on/off
03-03-14	TUESDAY PROG 2		on/off
03-03-15	WEDNESDAY PROG 2		on/off
03-03-16	THURSDAY PROG 2		on/off
03-03-17	FRIDAY PROG 2		on/off
03-03-18	SATURDAY PROG 2		on/off
03-03-19	SUNDAY PROG 2		on/off

PROGRAM 3			
<i>menu level</i>	<i>selection</i>	<i>meaning</i>	<i>possible values</i>
03-03-20	START PROG 3	activation time	time - OFF
03-03-21	STOP PROG 3	deactivation time	time - OFF
03-03-22	MONDAY PROG 3	day of reference	on/off
03-03-23	TUESDAY PROG 3		on/off
03-03-24	WEDNESDAY PROG 3		on/off
03-03-25	THURSDAY PROG 3		on/off
03-03-26	FRIDAY PROG 3		on/off
03-03-27	SATURDAY PROG 3		on/off
03-03-28	SUNDAY PROG 3		on/off

PROGRAM 4			
<i>menu level</i>	<i>selection</i>	<i>meaning</i>	<i>possible values</i>
03-03-29	START PROG 4	activation time	time - OFF
03-03-30	STOP PROG 4	deactivation time	time - OFF
03-03-31	MONDAY PROG 4	day of reference	on/off
03-03-32	TUESDAY PROG 4		on/off
03-03-33	WEDNESDAY PROG 4		on/off
03-03-34	THURSDAY PROG 4		on/off
03-03-35	FRIDAY PROG 4		on/off
03-03-36	SATURDAY PROG 4		on/off
03-03-37	SUNDAY PROG 4		on/off

Submenu 03 - 04 - program week-end

It allows you to enable, disable and set the functions of the programmable thermostat for the weekend (days 5 and 6, that is Saturday and Sunday).

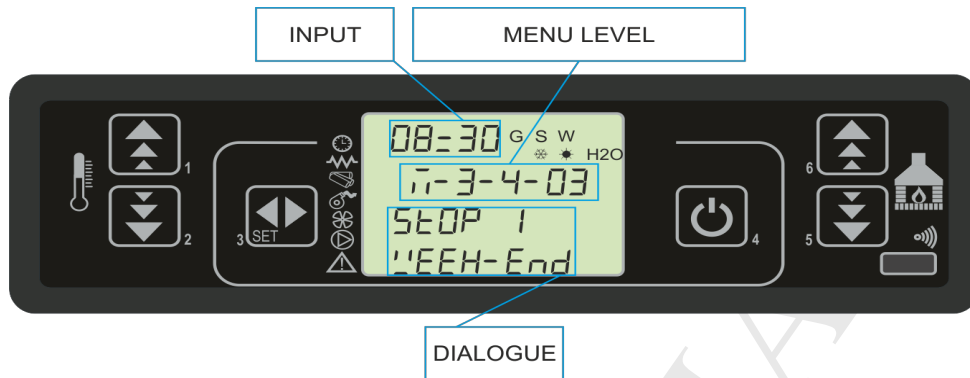

SUGGESTION: in an attempt to avoid confusion and unwanted switch-on and switch-off stages, activate only one program at a time if you are unsure of exactly what is that you wish to obtain.

Deactivate the daily program if you wish to use the weekly program. Always keep the weekend program disabled if using the weekly program in programs 1, 2, 3 and 4.

Activate the weekend program only after deactivating the weekly program.

7.5 Menu 04 - language selection

It allows you to select the dialogue language among the list of available languages.

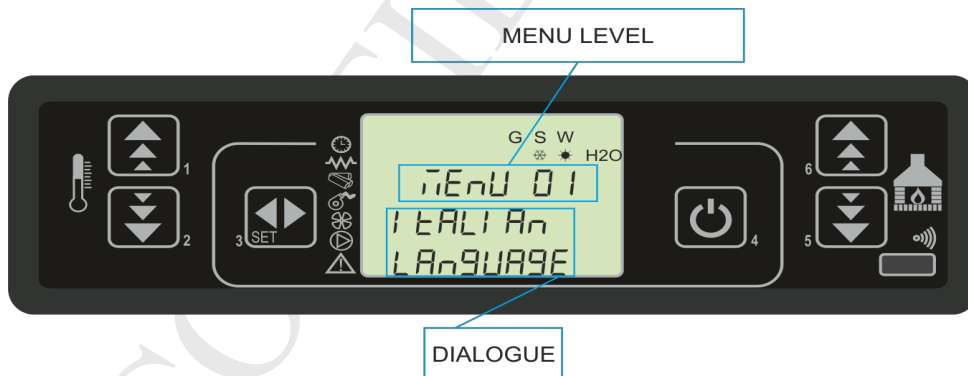
**7.6 Menu 05 - stand-by mode**

Activate the "STANDBY" mode which switches off the stove once the room temperature has exceeded the SET temperature for longer than the amount of time defined by Pr44.

After the shutdown has been completed in cases as such, reignition can occur only when the following conditions have been met:

$$T_{SET} < (T_{ambiente} - Pr43)$$

7.7 Menu 06 - alarm mode

When "OFF" disables the sound.

7.8 Menu 07 - initial charging

It allows you to preload the pellets when the stove is off and cold for an amount of time equal to 90". Start with the P1 button and stop with the P4 button.

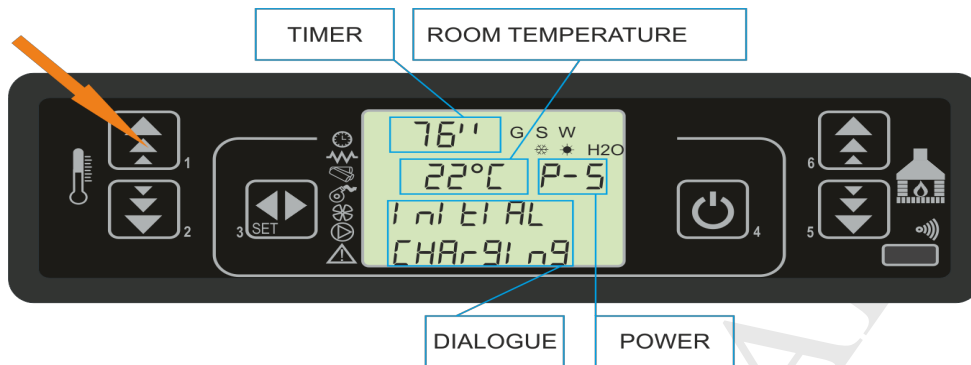

7.9 Menu 08 - stove status

Visualize the instant status of the stove reporting the status of the various devices connected to it. Several pages are available for viewing in order.

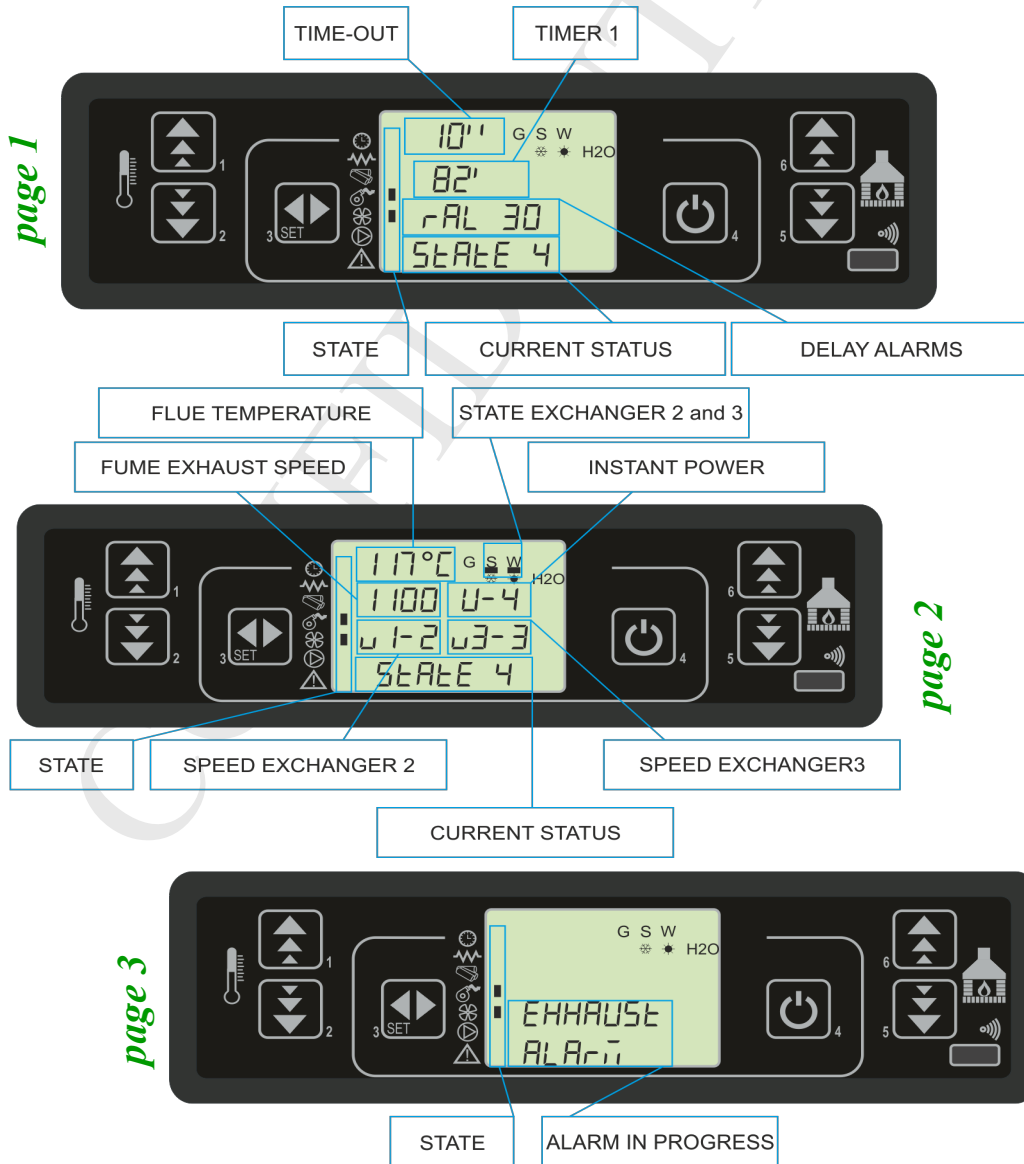

OPERATING
STATUS

8. OPERATING MODE (USER)

Here, as follows, is a description of the normal operating of the control board that has been correctly installed in an air stove with regards to the functions available to the user. The indications shown below refer to the control board with the programmable thermostat option. In the paragraphs that follow the technical programming mode is analyzed.

Before lighting the stove the display is presented as in *figure 16*.

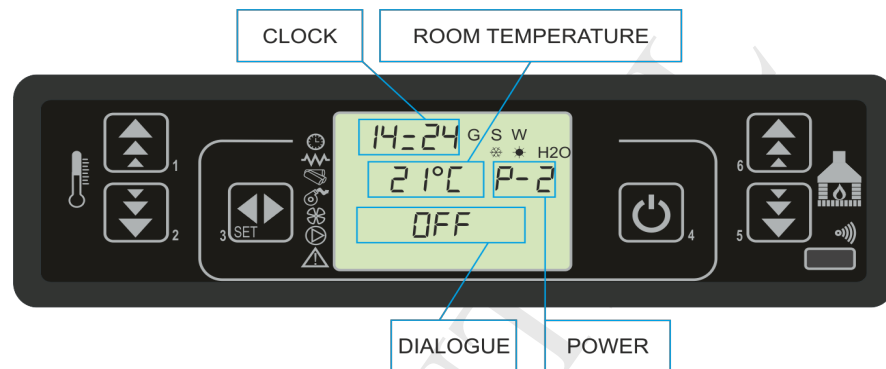

fig. 16

8.1 Lighting the stove

To light the stove hold the P4 button for a few seconds. The lighting of the stove is signaled on the display as pictured in *figure 17*.

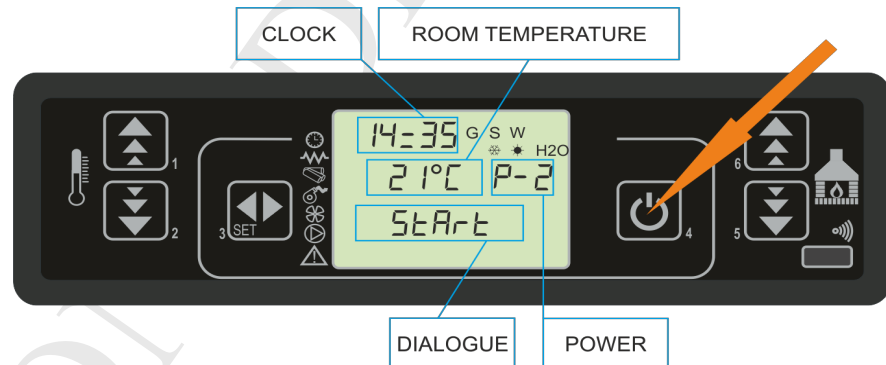

fig. 17

8.2 Lighting phase

The stove carries out the lighting phases in a sequence according to the process defined by the settings that manage the levels and timing. See the following table and **APPENDIXES A and C**.

START UP

USER OPERATING MODE

8.3 Transition from off to work

The table illustrates the way in which the stove reaches working mode when no alarms sound and no errors occur. Please see the following paragraphs to understand what are the inspections that the stove performs during the startup phase and once it has turned on.

The various ancillary functions (clearing, etc.) are described as well.

state	duration	devices				conditions for transition to next state
		igniter	exhaust	auger	exchanger	
OFF	-	OFF	OFF	OFF	OFF	ON/OFF
START - CLEAN IN.	Pr33	OFF	ON	OFF	OFF	elapsed time Pr33
WARM UP	Pr34	ON	ON	OFF	OFF	elapsed time Pr34
PELLET PRELOAD	Pr40	ON	ON	ON	OFF	elapsed time Pr40
AWAITING FLAME	Pr41	ON	ON	OFF	OFF	elapsed time Pr41
PELELT LOAD	-	ON	ON	ON	OFF	flue temperature > Pr13
FIRE	Pr02	OFF	ON	ON	ON	elapsed time Pr02
WORKING	-	OFF	ON	ON	ON	room temperature < SET temperature flue temperature < Pr14
MODUALTION	-	OFF	ON	ON	ON	room temperature > SET temperature flue temperature > Pr14
ASHPAN CLEANING	Pr12	OFF	ON	ON	ON	frequency Pr03
WORKING	-	OFF	ON	ON	ON	ON/OFF to switch off
FINAL CLEANING	Pr39 (*)	OFF	ON	OFF	-	(*) Pr39 starts when Tfumi < Pr13

USER OPERATING MODE

OPERATING
STATUSLIGHTING
FAILURE
ALARM

WORKING

ADJUSTING
ROOM
TEMPERATURE
SET

8.4 Lighting failure

Once the Pr01 time has elapsed, if the flue temperature has not reached the minimum temperature allowed, setting Pr13, reached with a gradient of 2°C/min, the alarm will sound.

8.5 Working mode

If the lighting phase is successful, the stove transitions to the working phase which represents the normal functioning mode.

If the flue temperature is higher than Pr15 the exchangers are enabled.

Exchangers no. 2 and no. 3 are activate only if they have been enabled.

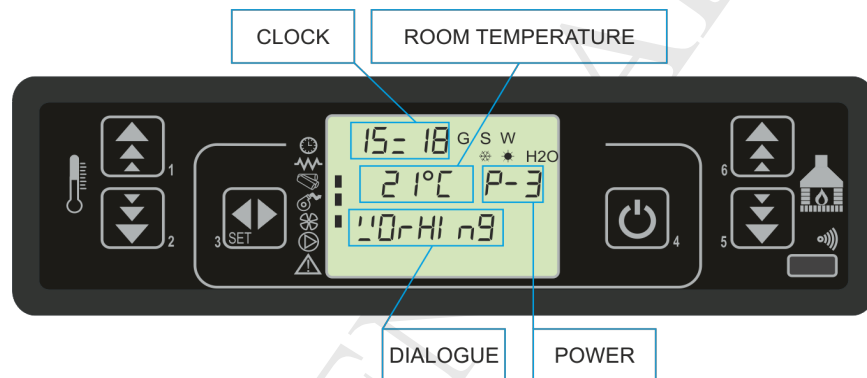

fig. 18

8.6 Adjusting the room temperature setting

To adjust the room temperature setting, simply press the P1 and P2 buttons. The display will indicate the current status of the SET temperature, figure 19.

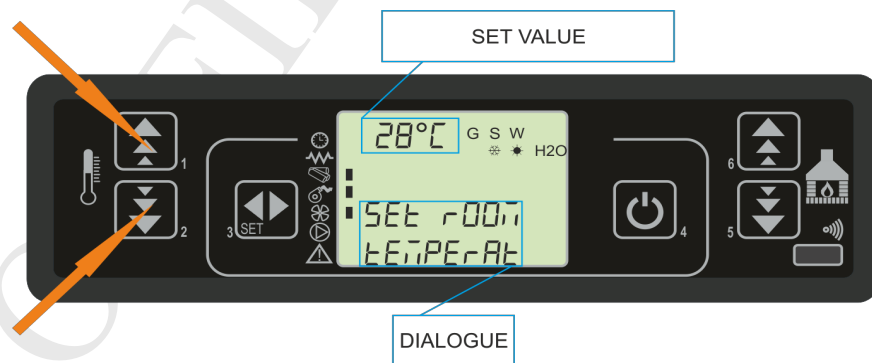

fig. 19

8.7 How to use the external thermostat/programmable thermostat

If you wish to use an external room thermostat, connect to the TERM clips (connector CN7 pin 7-8).

- **termostato esterno:** on the stove select a SET temperature equal to 7°C.
- **cronotermistato esterno:** on the stove select a SET temperature equal to 7°C and disable the crono function in the 03-01 menu.

The stove will be enabled while the stove is on and at the end of contact.

USER OPERATING MODE

8.8 The room temperature reaches the SET temperature

Once the room temperature reaches the set temperature or the flue temperature has reached Pr13, the heating power is automatically brought to the lowest point, MODULATION condition, see *figure 20*.

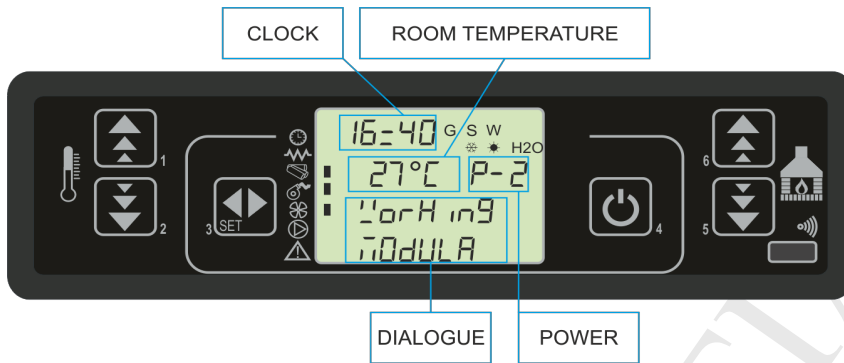

fig. 20

If standby mode has been activated, the stove will switch off with a delay equal to the Pr44 time after having reached the set temperature. The reignition will occur when the following conditions have been met:

$$T_{\text{ambiente}} > (T_{\text{SET}} + \text{Pr43})$$

8.9 Cleaning the ashpan

During normal operation in the working phase, "CLEAN ASHPAN" mode is activated at intervals established by the Pr03 setting and for the amount of time established by the Pr12 setting.

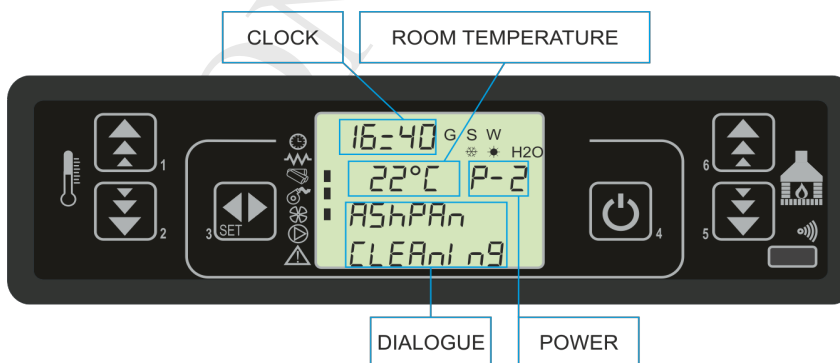

fig. 21

OPERATING
STATUS

WORKING

SHUT DOWN

ASHPAN
CLEANING
WORKING

USER OPERATING MODE

OPERATING
MODE**8.10 Switching off the stove**

To switch off the stove simply press the P4 button for about 2 seconds.

The auger is immediately stopped and the flue is brought to high speed.

The FINAL CLEANING phase is carried out.
The flue is disabled once the Pr39 time has elapsed after the flue temperature has fallen under that of the Pr13 setting.

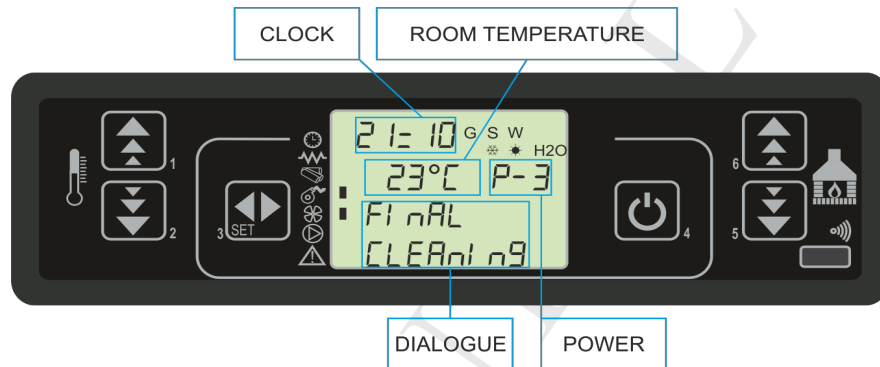

fig. 22

SHUT DOWN

8.11 Stove in off mode

fig. 23

OFF

8.12 Reigniting the stove

It won't be possible to reignite the stove until the flue temperature falls under the temperature indicated by the Pr13 setting and a safe amount of time has passed indicated by the Pr38 setting.

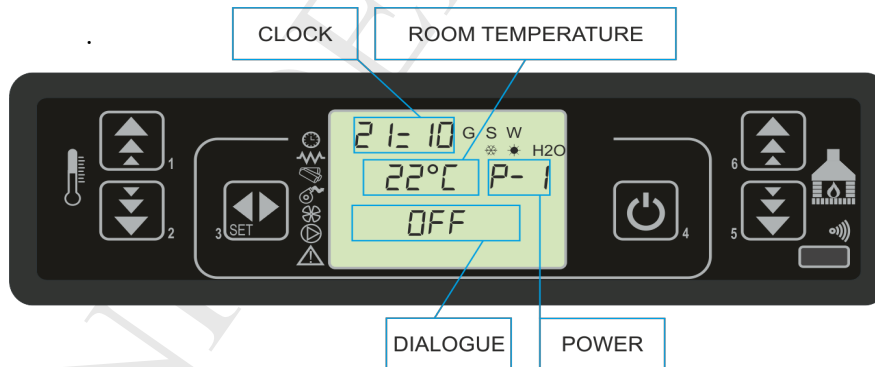
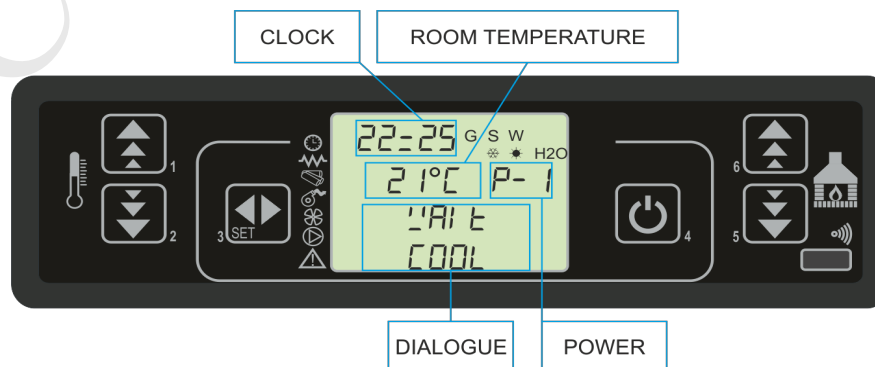

fig. 24

REIGNITE

USER OPERATING MODE

9. WHAT HAPPENS IF...

9.1 The pellet does not light

In the case of lighting failure, the NO LIGHT alarm message will be visible as illustrated in *figure 25*.

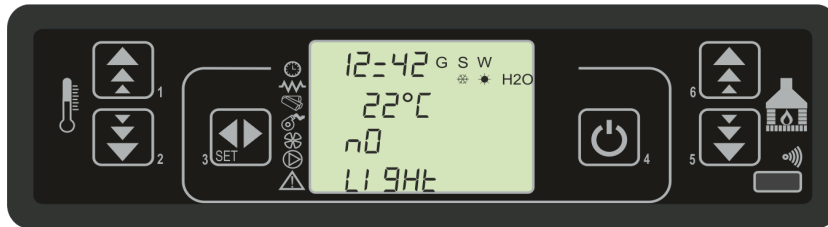

fig. 25

Press P4 to bring the stove back to standard condition.

9.2 There is a power outage (black out)

Pr48 = 0

If there is a power outage, when the stove turns back on, it will go into the FINAL CLEANING state and will wait for the flue temperature to drop to a temperature lower than Pr13.

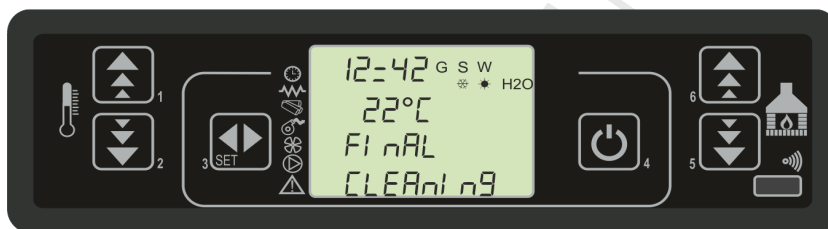

fig. 26

Pr48 = T seconds

After a power outage, based on the state in which the stove was before the black out, the following scenarios could take place:

<i>previous state</i>	<i>length of black out</i>	<i>new state</i>
off	any	off
lighting	< T	lighting
pellet load without prelaod	< T	pellet load
pellet load with prelaod	any	off
await fire	< T	await fire
working	< T	working
clean ashpan	< T	clean ashpan
off	< T	off

In all cases in which the duration of the black out is greater than T, the stove will shut down.

OPERATING
STATUS

NO FIRE
ALARM

POWER
OUTAGE

WHAT HAPPENS IF...

ALARMS

10. ALARMS

In the case of a functioning irregularity, the control board intervenes and signals the problem operating differently based on the type of alarm. The following alarms could sound:

Origin of the alarm	Display
Flue gas temperature probe	ALARM SOND FUMI
Flue gas over-temperature	ALARM HOT TEMP
Ignition failure	ALARM NO FIRE
Shut down during working mode	ALARM NO FIRE
Power supply failure	COOL FIRE (refer to par. 9.2)
Auger safety pressure switch	ALARM DEP FAIL
General safety thermostat	ALARM SIC FAIL
Exhaust malfunction	ALARM FAN FAIL

Every alarm causes the stove to immediately shut down

State of alarm occurs after reaching the Pr11 time and it is possible to reset it by pressing the P4 button.

10.1 Flue gas temperature probe alarm

This alarm sounds when the flue gas temperature probe malfunctions or is disconnected. In such cases the stove will shut down.

FLUE GAS
TEMPERATURE
PROBE

fig. 27

10.2 Flue gas over-temperature alarm

This alarm sounds when the flue gas temperature probe measures a temperature that is higher than 280°C. The display will portray the message illustrated in figure 28.

FLUE GAS
OVER-
TEMPERATURE

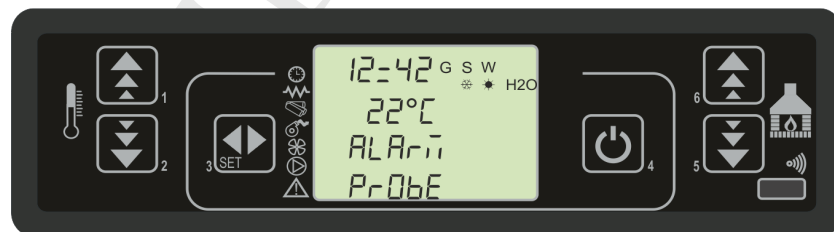
fig. 28

In such case the stove will immediately shut down.

ALARMS

10.3 Ignition failure alarm

This alarm sounds when the lighting phase fails.

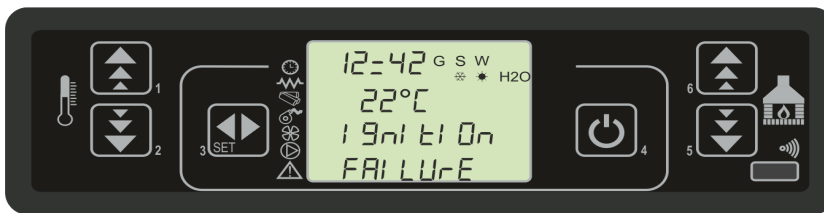

fig. 29

In such cases the stove will immediately begin to shut down.

10.4 Shut down during working mode alarm

If the flame goes out during working mode and the flue temperature drops below the minimum working threshold (parameter Pr113), the alarm sounds as illustrated in figure 30.



fig. 30

In such cases the stove will immediately begin to shut down.

10.5 Pressure switch for auger safety alarm

If the pressure switch measures a pressure lower than the threshold, it intervenes in order to stop the auger (when the auger is working) and, at the same time, through the AL2 clip in CN4, it allows the control board to acquire this change in state. On the display, the message "Alarm Dep Fail" will appear and the system will stop.

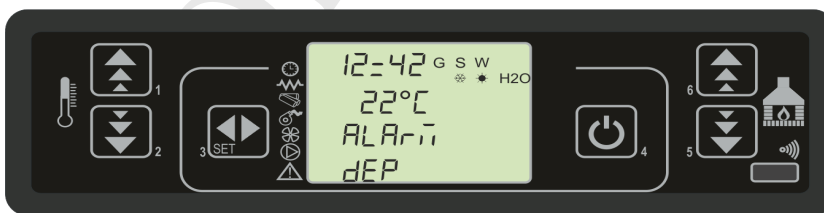

fig. 31

ALARMS

IGNITION
FAILURESHUT DOWN
WHILE
WORKINGDEPRESSION
FAILURE

ALARMS

ALARMS

GENERAL
SAFETY
THERMOSTAT
INTERVENTIONFUME
EXHAUST
MALFUNCTION**10.6 General thermostat alarm**

If a general safety thermostat measures a temperature higher than the threshold, it intervenes in order to stop the auger (when it is working) and, at the same time, through the A11 clip in CN4, it allows the control board to acquire this change in state. On the display, the message **ALARM SIC FAIL** will appear and the system will stop.



fig. 32

10.7 Exhaust malfunction alarm

If the fume exhaust malfunctions, the stove will stop and the message **ALARM FAN FAIL** will appear on the display as illustrated in the following figure.

The stove will immediately begin to shut down.

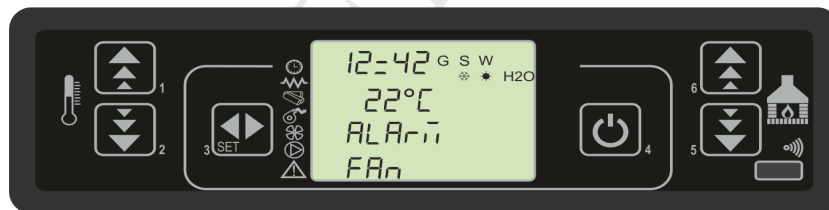

fig. 33

11. OPERATING MODE (TECHNICAL MENU)

N.B. The following section is reserved for professional technicians with specific abilities concerning the product. Random changes in the settings could cause severe damage to the device, people and the environment. For this, **Micronova** assumes no responsibility.

To gain access to the TECHNICAL MENU press the MENU (P3) button and scroll, with the use of the P5 and P6 the buttons, through the various submenus until you reach submenu 9 as illustrated in figure 34.



fig. 34

The following table illustrates the organization of the various submenus of the technical menu.

level 1	level 2	level 3	level 4	value
09 - technical settings		passcode		
	01 - pellet type			
	02 - chimney type			set
	03 - database			see databases
	04 - channel data			
		01 - enable can.		on/off
		02 - air speed 2-1		value
		03 - air speed 2-2		value
		04 - air speed 2-3		value
		05 - air speed 2-4		value
		06 - air speed 2-5		value
		07 - air speed 3-1		value
		08 - air speed 3-2		value
		09 - air speed 3-3		value
		10 - air speed 3-4		value
		11 - air speed 3-5		value
	05 - various settings			
		01 - block reignition		value
		02 - min exhaust off		value

<i>level 1</i>	<i>level 2</i>	<i>level 3</i>	<i>level 4</i>	<i>value</i>
		03 - start preload		value
		04 - await flame		value
		05 - exhaust preload		value
		06 - delta on/off auto		value
		07 - delay off auto		value
		08 - adjust power		value
		09 - enable remote		on/off
		10 - lock keyboard		on/off
		11 - black out		on/off
		12 - service hours		on/off
		13 - lambda sensor		on/off
		14 - entrance flow		on/off
		15 - free		-
		16 - free		-
	06 - output test			
		01 - spark plug test		value
		02 - auger test		value
		03 - flue test		value
		04 - fan 1 test		value
		05 - fan 2 test		value
		06 - fan 3 test		value
	07 - factory settings			
	08 - reset part. hours	passcode		APPENDIX C
	09 - reset alarms	passcode		APPENDIX C
	10 - meter memory	total hours		-
		partial hours		-
		start number		-
		alarm memory 1		-
		alarm memory 2		-
		alarm memory 3		-
		alarm memory 4		-
		alarm memory 5		-

11.1 Submenu 09 - 01 - 01 load pellet



fig. 35

Select with P1 and P2 the amount of pellet loading. Confirm with P3.

11.2 Submenu 09 - 02 - 01 chimney type



fig. 36

Select with P1 and P2 the speed of the exhaust. Confirm with P3.

11.3 Submenu 09 - 03 databases

The device has a series of predefined internal settings called **DATABASES**. The numbers of these setting vary based on the version of the device. They are not modifiable so that, for example, they can be adapted to different types of stoves without having to program one setting at a time or in relation to particular needs.

To load the databases, simply enter the correct key that corresponds to the desired database by referring to the table in **APPENDIX A**.

11.4 Submenu 09 - 04 channel data

It allows you to enable the outputs relative to fans no.2 and no.3.

For each of these you can set the tension in function with the power level.

11.5 Submenu 09 - 05 various resets

Allows for the setting of a series of operation parameters. Please refer to **APPENDIX A**.

11.6 Submenu 09 - 06 output test

Select the output device that you wish to activate.

For the fume extractor and the exchanger fans it is possible to set the power to apply during the test.

The test activation time can be preselected for the auger.

By pressing the P4 button, the test will be interrupted.

11.7 Submenu 09 - 07 factory reset

F9 key: access to the flue probe reset (see paragraph 11.11).

Parameter description: see **APPENDIX A**.

11.8 Submenu 09 - 08 reset partial hours

Accessible only with a passcode.

Reset the partial functioning hours.

11.9 Submenu 09 - 09 reset alarms

Reset the memory of the last alarms.

Accessible only with a passcode.

11.10 Submenu 09 - 10 meter memory

The following memory logs are viewed in sequence by pressing the P5 and P6 buttons:

- Total hours
- Partial hours
- Number of startups
- Alarm memory no. 1
- Alarm memory no. 2
- Alarm memory no. 3
- Alarm memory no. 4
- Alarm memory no. 5

11.11 Flue probe reset

To reset the flue probe, simply access the factory reset menu (09 – 07), once the flue probe is plugged in, and insert the passcode: F9.

The value on the display represents the temperature measured by the probe. Press buttons **P1** and **P2** (*increase and decrease temperature*) to match the temperature measured by the probe with the temperature measured by another thermometer placed near the probe.

If the procedure is carried out when the stove is off and cold, simply match it to the room temperature measured by another thermometer.

An example follows in the figure below:

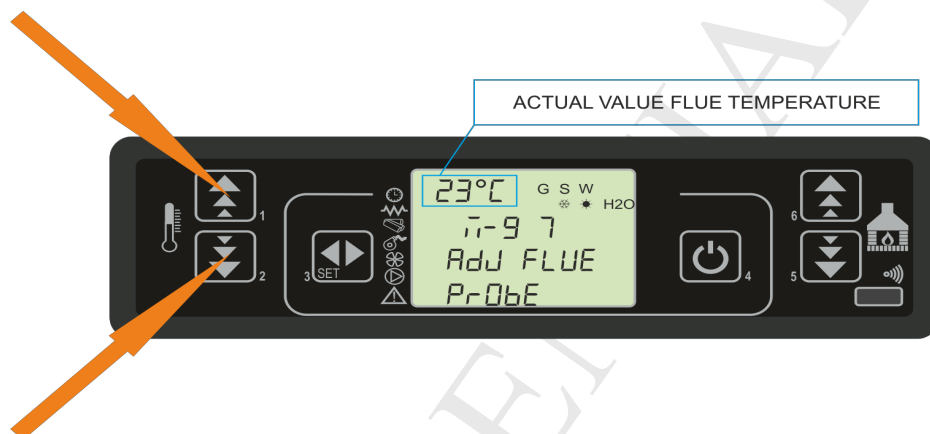

fig. 37

Confirm the reset with the P3 button.

11.12 Structure of the control board memory

The block diagram in *figure 38* briefly describes the structure of the memory and the mode of access from the outside.

As you can see, it is possible to access the **EEPROM** memory content directly from the console in order to read or adjust the UT and PR parameters.

The same can be done through the serial connection and the **SERAMI** software with the use of a personal computer.

It is also clear how the content for databases o0, o1, o2,o9 is neither accessible nor adjustable from the outside.

It is possible to load a database on the **EEPROM** memory through the use of the console. The database gets added to the content of the **EEPROM** memory when concerning the PR parameters (the UT parameters are excluded from this procedure).

The part of the **FLASH** memory that contains the operating program is accessible from the outside only by using the **SERAMI** and the specific firmware update files made available by Micronova.

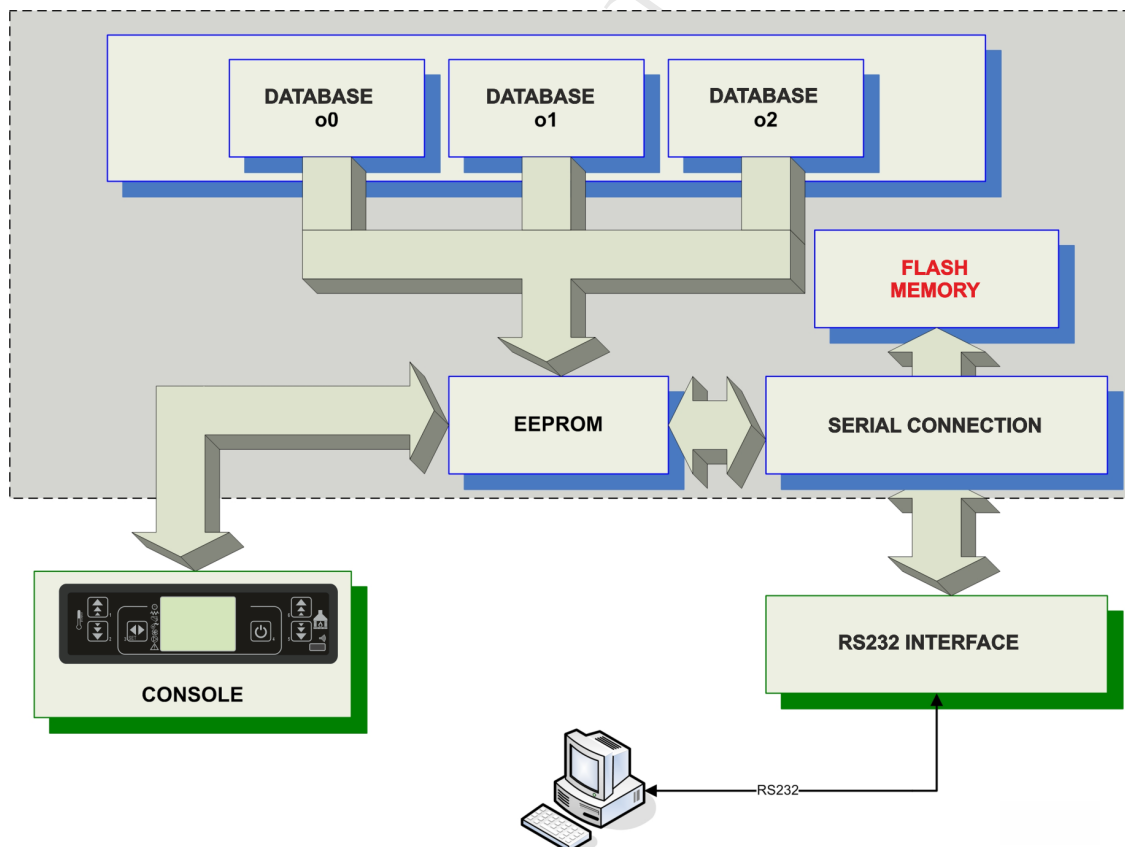

fig. 38

11.13 Create personalized databases (*)

By using a personal computer, the **SERAMI** software with a serial connection and the control board and relative RS232 interface, you can create and memorize personalized databases. To do such you must do the following:

1. Load the default database into the control board (o0, o1, etc.) from the 09-03 menu that is closest to your needs. Next, adjust the settings that you wish to personalize by accessing menu 09-07 (factory resets).
2. With **SERAMI**, from the instruments menu, select “manage **EEPROM**”:
 - 2.1 Select “Backup” with the button on the top left.
 - 2.2 Backup the data.
 - 2.3 Save the backup with a suitable name (es. MyDatabase01).
3. Detach the serial interface connector from the control board from which the database had been extracted.
4. Insert the serial interface connector into the control board to which you wish to send the database.
5. With **SERAMI**, from the instruments menu, select “manage **EEPROM**”:
 - 5.1 Select “Restore Backup” with the second button on the left.
 - 5.2 With the “Open Backup” button select the database file you wish to insert the control board, for example MyDatabase01.bk.
 - 5.3 Select the “Restore Backup” option.

NOTE: It is a good idea to verify the serial port settings after the first connection to the control board by going to the SERAMI menu:

From the menu select *Connection* and then *Local Serial*

Inside the window select the button *CLOSE SERIAL* and set according to the following :

BaudRate: 1200

Data Bit: 8

Parity:none

Serial port: the one available in the PC (non occupied by other programs or devices).

Stop Bit: 2

Timeout: 120

Select the *OPEN SERIAL* button and then the *CLOSE WINDOW* button

From this point on, the system will operate according to the PR parameters copied from the original starting system.
In this way, many changes and configurations can be made according to your needs.

N.B everytime a predefined database o0, o1, etc. is loaded ,the personalized settings will be overwritten and the **EEPROM writing will have to be redone, following this procedure starting from step 4.**

(*) Please refer to the **SERAMI** software manual.

12. CONTROL BOARD FIRMWARE UPDATE (*)

By using a firmware update file provided by Micronova, you can update the control board's operating software with a personal computer and the **SERAMI** software with a serial connection to the control board and the relative RS232 interface.

- A. Remove the electrical power from the control board.

Connect the serial cable from the RS232 interface. It must be connected correctly to the personal computer with the serial port correctly configured with the **SERAMI**.

- B. From the "INSTRUMENTS" menu and from the following "UPDATE FIRMWARE" submenu, access the procedure according to the instructions listed below.
- C. Select the **ATMEL** option.
- D. Select the file containing the stove's operating program, see *figure 39*.

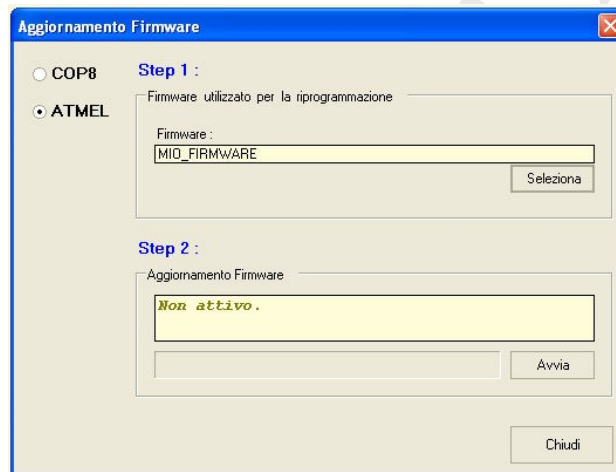

fig. 39

- E. Select the "START" button and wait for the message that reads "Shut off and turn on the control board". Power the control board and wait for the progress bar to fill up.
- F. Select the "CLOSE" button to exit the procedure.

After completing the update you must load the values of one of the databases in order to assign consistent values to the parameters, see paragraph 10.2.

If you do not have a **SERAMI** (.snet) configuration file, access the "APPLICATIONS" page on the Micronova website to download the file.

From here, find "Download SeramiNet configuration file" and type the exact name of the ENC file without the extension.

For example, if the ENC file is called "MY_FIRMWARE.ENC", type "my_firmware" (not case sensitive) and select the "SEND QUERY" button.

Contact Micronova if the download is not available.

(*) Refer to **SERAMI** software manual.

APPENDIX A : Parameter table

Here, as follows, is a parameter table. The the values indicated in the column on the right refer to a few DATABASES which could have variations based on the version.

Parameter	Menu level	Description	Unit of measure	Field values admitted	o0	o1	o2
Pr01	M - 9 - 7 - 01	Maximum time for ignition cycle	second	5 - 25			
Pr02	M - 9 - 7 - 02	Time for start up	minute	2 - 12			
Pr03	M - 9 - 7 - 03	Interval of time between two ashpan cleanings	minute	3 - 240			
Pr04	M - 9 - 7 - 04	Auger motor on time during start up phase	second	0.1 - 4			
Pr05	M - 9 - 7 - 05	On time during start up phase	second	0.1 - 4			
Pr06	M - 9 - 7 - 06	Auger motor on time during working phase at power level 1	second	0.1 - 4			
Pr07	M - 9 - 7 - 07	Auger motor on time during working phase at power level 2	second	0.1 - 4			
Pr08	M - 9 - 7 - 08	Auger motor on time during working phase at power level 3	second	0.1 - 4			
Pr09	M - 9 - 7 - 09	Auger motor on time during working phase at power level 4	second	0.1 - 4			
Pr10	M - 9 - 7 - 10	Auger motor on time during working phase at power level 5	second	0.1 - 4			
Pr11	M - 9 - 7 - 11	Alarm delay	second	20 - 90			
Pr12	M - 9 - 7 - 12	Duration ashpan cleaning	second	0 - 120			
Pr13	M - 9 - 7 - 13	Minimum flue temperature to consider stove on	°C	40 - 180			
Pr14	M - 9 - 7 - 14	Flue temperature to pass to ECO-MODULA mode	°C	110 - 250			
Pr15	M - 9 - 7 - 15	Flue temperature threshold for exchanger switch-on	°C	50 - 210			
Pr16	M - 9 - 7 - 16	Speed fume extractor during on phase	RPM	300 - 2800			
Pr17	M - 9 - 7 - 17	Speed fume exhaust during start up phase	RPM	300 - 2800			
Pr18	M - 9 - 7 - 18	Speed fume exhaust during working phase at power level 1	RPM	300 - 2800			

Parameter	Menu level	Description	Unit of measure	Field values admitted	o0	o1	o2
Pr19	M - 9 - 7 - 19	Speed fume exhaust during working phase at power level 2	RPM	300 - 2800			
Pr20	M - 9 - 7 - 20	Speed fume exhaust during working phase at power level 3	RPM	300 - 2800			
Pr21	M - 9 - 7 - 21	Speed fume exhaust during working phase at power level 4	RPM	300 - 2800			
Pr22	M - 9 - 7 - 22	Speed fume exhaust during working phase at power level 5	RPM	300 - 2800			
Pr23	M - 9 - 7 - 23	Speed exch. motor 1 during working phase at power level 1	Volt	65 - 225			
Pr24	M - 9 - 7 - 24	Speed exch. motor 1 during working phase at power level 2	Volt	65 - 225			
Pr25	M - 9 - 7 - 25	Speed exch. motor 1 during working phase at power level 3	Volt	65 - 225			
Pr26	M - 9 - 7 - 26	Speed exch. motor 1 during working phase at power level 4	Volt	65 - 225			
Pr27	M - 9 - 7 - 27	Speed exch. motor 1 during working phase at power level 5	Volt	65 - 225			
Pr28	M - 9 - 7 - 28	Shut down temperature threshold	°C	50 - 250			
Pr29	M - 9 - 7 - 29	Speed fume exhaust during the ashpan cleaning phase	RPM	700 - 2800			
Pr30	M - 9 - 7 - 30	Auger motor on time during cleaning phase Enable	second	0 - 4			
Pr31	M - 9 - 7 - 31	Enable encoder	-	0 - 1			
Pr32	M - 9 - 7 - 32	Brake auger time	second	0 - 0.5			
Pr33	M - 9 - 7 - 33	Duration initial cleaning	second	0 - 60			
Pr34	M - 9 - 7 - 34	Heat up time	second	0 - 255			
Pr35	M - 9 - 7 - 35	Speed fume exhaust during the initial cleaning phase	RPM	500 - 2800			
Pr36	M - 9 - 7 - 36	Speed fume exhaust during the heat up phase	RPM	500 - 2800			
Pr37	M - 9 - 5 - 37	Speed fume exhaust during the await flame phase	RPM	500 - 2800			

Parameter	Menu level	Description	Unit of measure	Field values permitted	o0	o1	o2
Pr38	M - 9 - 5 - 01	Lock reignition	second	0 - 10			
Pr39	M - 9 - 5 - 02	Fume exhaust shut down time	minute	0 - 20			
Pr40	M - 9 - 5 - 03	Preload time during ignition	second	0 - 255			
Pr41	M - 9 - 5 - 04	Waiting time after preload	second	0 - 255			
Pr42	M - 9 - 5 - 05	Speed fume exhaust during preload phase	RPM	600 - 2800			
Pr43	M - 9 - 5 - 06	Hysteresis temperature ON/OFF in automatic mode	°C	0 - 30			
Pr44	M - 9 - 5 - 07	Shut down delay in automatic mode	minute	0 - 120			
Pr45	M - 9 - 5 - 08	Power change delay	second	0 - 60			
Pr46	M - 9 - 5 - 09	Enable remote control	-	0 - 1			
Pr47	M - 9 - 5 - 10	Enable keyboard lock	-	0 - 1			
Pr48	M - 9 - 5 - 11	Automatic reignition after black out	second	0 - 60			
Pr56	M - 9 - 4 - 01	Enable duct fans	-	0 - 1			
Pr57	M - 9 - 4 - 02	Speed exchanger no. 2 power level 1	Volt	65 - 225			
Pr58	M - 9 - 4 - 03	Speed exchanger no. 2 power level 2	Volt	65 - 225			
Pr59	M - 9 - 4 - 04	Speed exchanger no. 2 power level 3	Volt	65 - 225			
Pr60	M - 9 - 4 - 05	Speed exchanger no. 2 power level 4	Volt	65 - 225			
Pr61	M - 9 - 4 - 06	Speed exchanger no. 2 power level 5	Volt	65 - 225			
Pr62	M - 9 - 4 - 07	Speed exchanger no. 3 power level 1	Volt	65 - 225			
Pr63	M - 9 - 4 - 08	Speed exchanger no. 3 power level 2	Volt	65 - 225			
Ps64	M - 9 - 4 - 09	Speed exchanger no. 3 power level 3	Volt	65 - 225			
Pr65	M - 9 - 4 - 10	Speed exchanger no. 3 power level 4	Volt	65 - 225			
Pr66	M - 9 - 4 - 11	Speed exchanger no. 3 power level 5	Volt	65 - 225			

How to interpret the auger timing parameters

The auger functioning command is temporal and is structured as follows: the period T=4s is established. During this time the motor is activated for the Pr04, Pr05, Pr06, Pr, 07, Pr08, Pr09 and Pr10 times based on the operating phase.

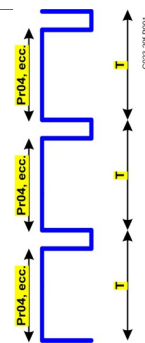

APPENDIX A

APPENDIX B : Start up sequence and working conditions

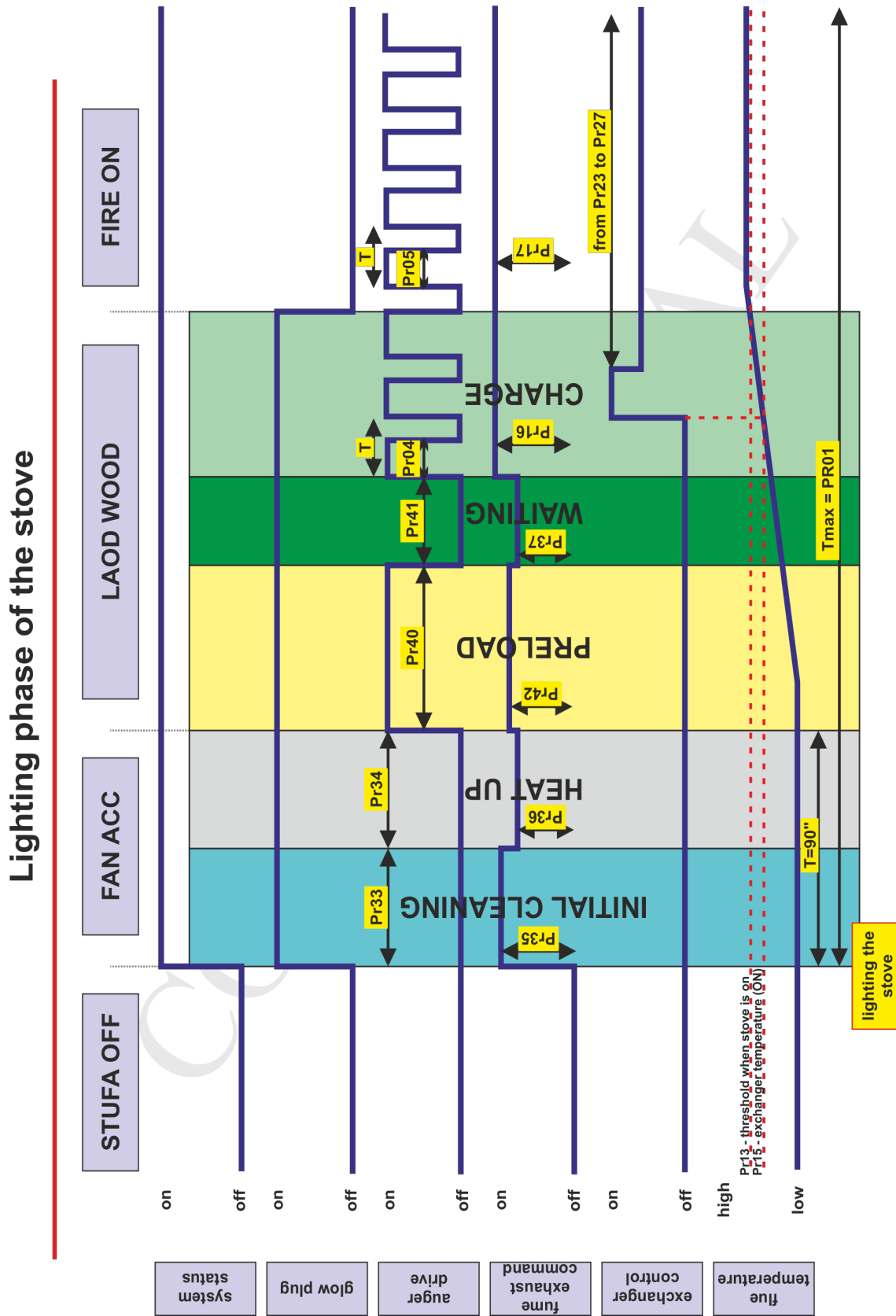

APPENDIX B

Work phase of the stove

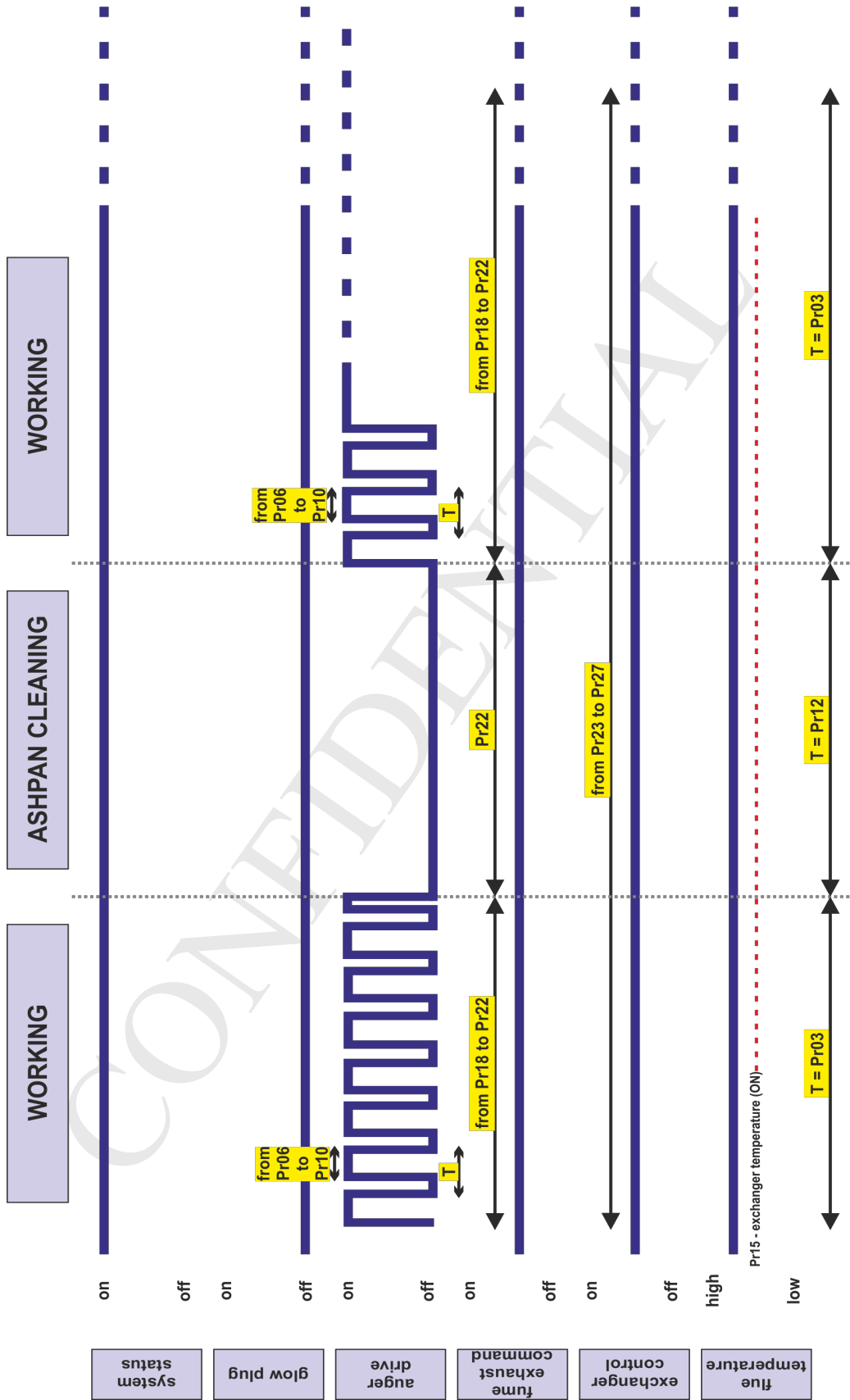

APPENDIX B

APPENDIX C : Usage parameters

<i>reference</i>	<i>value</i>
FW	LCD_ARIA_01.ENC
SERAMI	LCD_ARIA_01.SNET
Technical reset passcode	A9
Flue probe reset passcode	F9
Reset partial hours passcode	55
Reset alarms passcode	55

CONFIDENTIAL

Micronova	Control board I023	date 20/05/2016 page 83 of 83
------------------	---------------------------	----------------------------------

CONFIDENTIAL

INFORMATION

Micronova reserves the right to make changes and improvements to the present manual and to the object herein described in any moment and without warning.

*Reproduction without authorization from **Micronova** is prohibited, both in its entirety and partially.*

Micronova S.r.l.

Via A. Niedda, 3
35010 Vigonza (PD) - Italy

Tel.: +39 049 89 31 563
Fax: +39 049 89 32 442
e-mail: info@micronovasrl.com
internet: www.micronovasrl.com