



MPPT SOLAR CHARGER 3KW

PCM60X

User Manual

CONTENTS

1 ABOUT THIS MANUAL	1
1.1 Purpose	1
1.2 Scope	1
1.3 SAFETY INSTRUCTIONS	1
2 INTRODUCTION.....	2
2.1 Features.....	2
2.2 Product Overview.....	3
3. INSTALLATION.....	4
3.1 Unpacking and Inspection.....	4
3.2 Preparation	4
3.3 Mounting the Unit	4
3.4 Power Connection	5
3.5 Grounding and Ground Fault Interruption	7
3.6 Remote Temperature Sensor	7
3.7 Battery Voltage Sense	8
3.8 Communication Connections	9
4. OPERATION.....	11
4.1 Power-Up	11
4.2 Operation and Display Panel.....	11
4.3 LCD Display Icons	12
4.4 LCD setting	13
4.5 Reference Code	16
5. CHARGING LOGIC.....	17
5.1 3-stage Charging	17
5.2 Equalize Stage.....	19
5.3 Setting Parameter and Default Value.....	22
6. PARALLEL CHARGING FUNCTION	23
7. TROUBLE SHOOTING.....	24
8. SPECIFICATIONS	25

1 ABOUT THIS MANUAL

1.1 Purpose

This manual describes the assembly, installation, operation and troubleshooting of this unit. Please read this manual carefully before installations and operations.

Keep this manual for future reference.

1.2 Scope

This manual provides safety and installation guidelines as well as information on tools and wiring.

1.3 SAFETY INSTRUCTIONS



WARNING: This chapter contains important safety and operating instructions. Read and keep this manual for future reference.

1. Before using the unit, read all instructions and cautionary markings on the unit, the batteries and all appropriate sections of this manual.
2. Do not disassemble the unit. Take it to a qualified service center when service or repair is required. Incorrect re-assembly may result in a risk of electric shock or fire.
3. To reduce risk of electric shock, disconnect all wirings before attempting any maintenance or cleaning. Turning off the unit will not reduce this risk.
4. **CAUTION** – Only qualified personnel can install this device with battery.
5. **NEVER** charge a frozen battery.
6. For optimum operation of this charger, please follow required spec to select appropriate cable size. It's very important to correctly operate this charger.
7. Be very cautious when working with metal tools on or around batteries. A potential risk exists to drop a tool to spark or short circuit batteries or other electrical parts and could cause an explosion.
8. Please strictly follow installation procedure when you want to disconnect PV or battery terminals. Please refer to INSTALLATION section of this manual for the details.
9. **GROUNDING INSTRUCTIONS** -This charger should be connected to a permanent grounded wiring system. Be sure to comply with local requirements and regulation to install this charger.
10. **NEVER** cause short circuited on battery output.
11. **Warning!!** Only qualified service persons are able to service this device. If errors still persist after following troubleshooting table, please send this charger back to local dealer or service center for maintenance.

2 INTRODUCTION

Thank you for selecting this solar charge controller. This solar charge controller is an advanced solar charger with maximum power point tracking. Applying intelligent MPPT algorithm, it allows solar charge controller to extract maximum power from solar arrays by finding the maximum power point of the array.

The MPPT battery charging process has been optimized for long battery life and improved system performance. Self-diagnostics and electronic error protections prevent damage when installation errors or system faults occur. This charger also features multifunctional LCD with communication ports for remote battery temperature and voltage measurement.

2.1 Features

- Intelligent Maximum Power Point Tracking technology increases efficiency 25%~30%
- Compatible for PV systems in 12V, 24V or 48V
- Three-stage charging optimizes battery performance
- Maximum charging current up to 60A
- Maximum efficiency up to 98%
- Battery temperature sensor (BTS) automatically provides temperature compensation
- Automatic battery voltage detection
- Support wide range of lead-acid batteries including wet, AGM and gel batteries
- Integrated intelligent slot compatible with SNMP/MODBUS communication

2.2 Product Overview

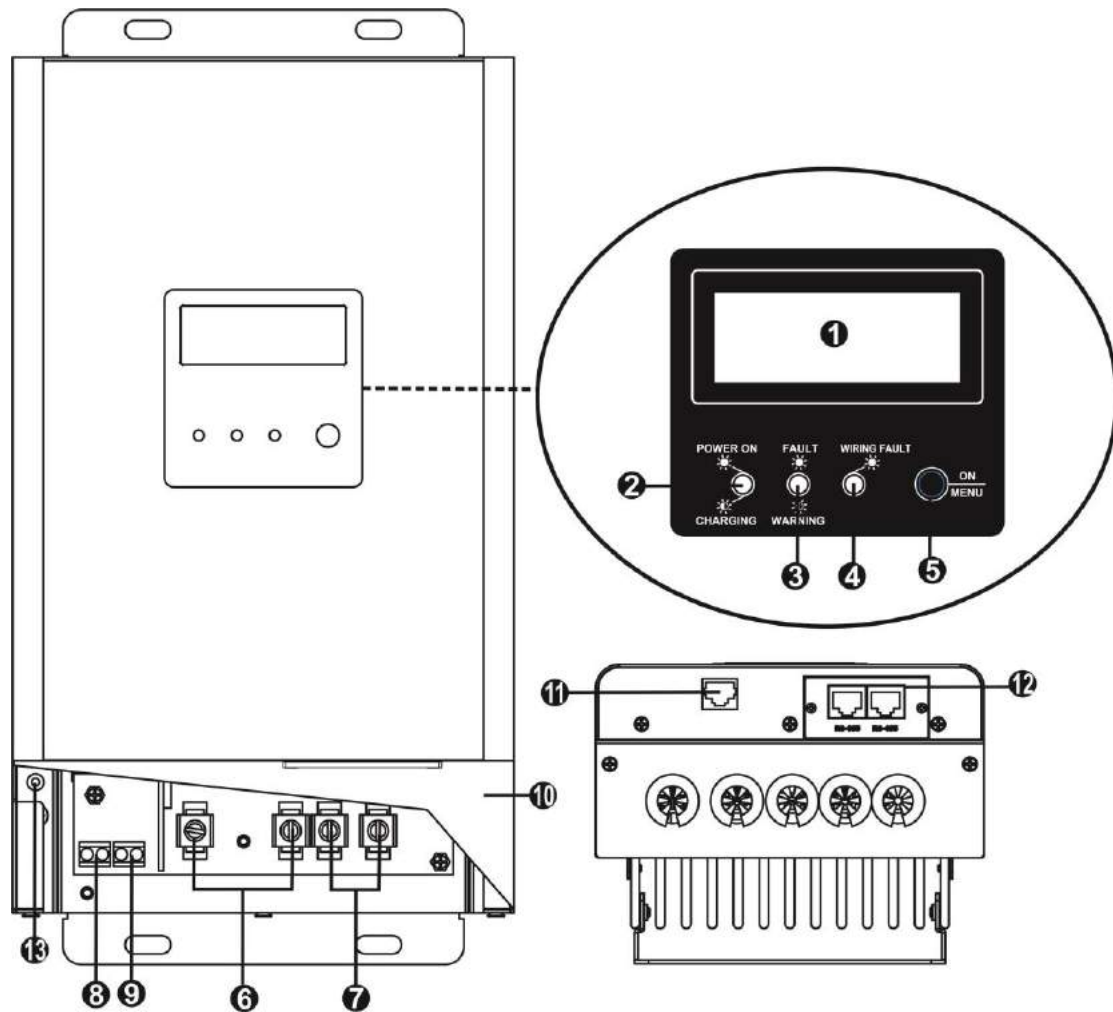

1. LCD display
2. Power On/Charging indicator
3. Fault and warning indicator
4. Wiring fault indicator
5. Operation button
6. PV connectors
7. Battery connectors
8. Remote temperature sensor terminal
9. Battery voltage sense terminal
10. Wiring box cover
11. Communication port
12. Intelligent slot
13. Grounding terminal

3. INSTALLATION

3.1 Unpacking and Inspection

Before installation, please inspect the unit. Be sure that nothing inside the package is damaged. You should have received the following items inside of package:

- Solar charge controller x 1
- User manual x 1
- Communication cable x 1
- **Battery Voltage Sense x 1**
- **Software CD x 1**

3.2 Preparation

Before connecting all wirings, please take off wiring box cover by removing screws as shown below.

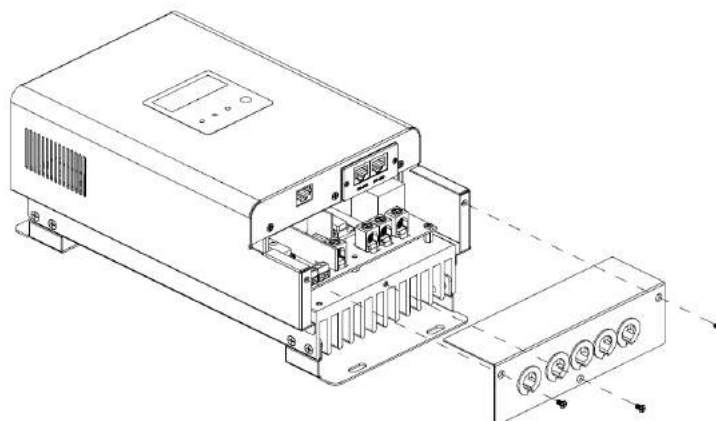

3.3 Mounting the Unit

Consider the following points before selecting where to install:

- This solar charge controller is designed in IP31 for indoor applications only.
- Do not mount the unit on flammable construction materials.
- Mount on a solid surface
- Install this charger at eye level in order to allow the LCD display to be read at all times.
- For proper air circulation to dissipate heat, allow a clearance of approx. 20 cm to the side and approx. 50 cm above and below the unit.
- The ambient temperature should be between 0°C and 55°C to ensure optimal operation.
- The recommended installation position is to be adhered to the wall vertically.

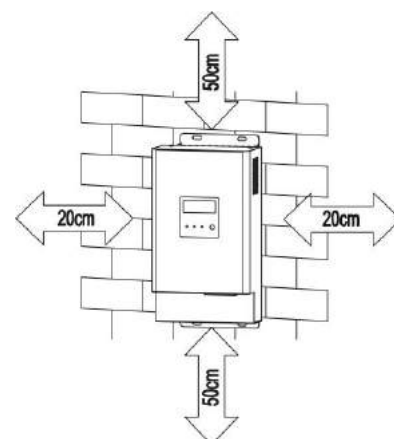

Install the unit to the wall by screwing four screws.

Refer to right chart.

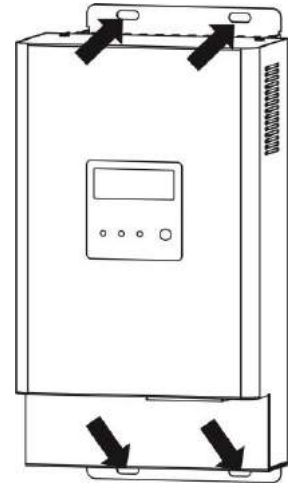

3.4 Power Connection

Wire size

The four large power terminals are sized for 14 - 2 AWG (2.5 - 35 mm²) wire. The terminals are rated for copper and aluminum conductors. Use UL-listed Class B 300 Volt stranded wire only. Good system design generally requires large conductor wires for solar module and battery connections that limit voltage drop losses to 2% or less.

Minimum Wire Size

The table below provides the recommended minimum wire size allowed for the charger. Wire types rated for 75°C and 90°C are listed.

Recommended wire size:

Typical Amperage	Wire Type	75°C Wire	90°C Wire
60A	Copper	4 AWG (25 mm ²)	6 AWG (16 mm ²)
	Aluminum	2 AWG (35 mm ²)	4 AWG (25 mm ²)

Overcurrent Protection and Disconnects

CAUTION: Circuit breakers or fuses must be installed in both battery and solar circuits.

The battery circuit breaker or fuse must be rated to 125% of the maximum current or more. The recommended breaker/fuse rating for use with the charger is listed in the below table.

Recommended breaker rating:

Minimum battery circuit breaker/fuse rating
1.25 x 60 Amps = 75.0 Amps

A disconnect is required for the battery and solar circuits to provide a means for removing power from the charger. Double pole switches or breakers are convenient for disconnecting both solar and battery conductors simultaneously.

Connect the Power Wires

WARNING: Shock Hazard

The solar modules can produce open-circuit voltages in excess of 100 Vdc when in sunlight. Verify if solar input breaker or disconnect has been opened (disconnected) before connecting system wires.

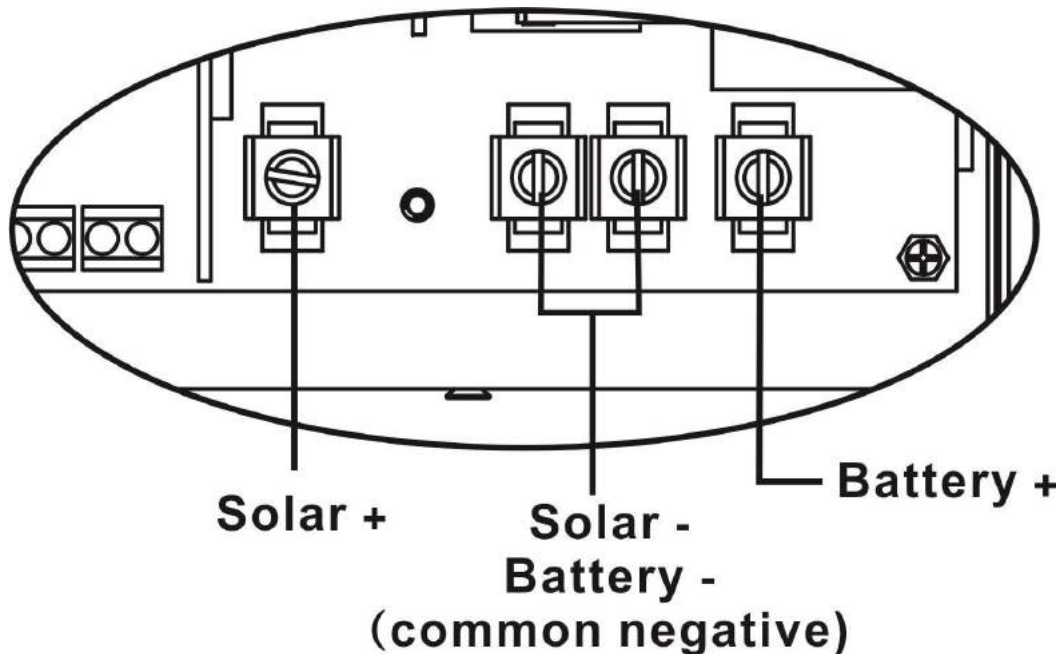

Connect terminals by following below steps (Refer to diagram above):

1. Make sure that the system input and output disconnect switches are both turned off before connecting power wires to the charger. There are no disconnecting switches inside the charger.
2. Make 4 power wires first. Remove insulation sleeve 10.5mm and the conductor should be plated Tin. Refer to the chart below.

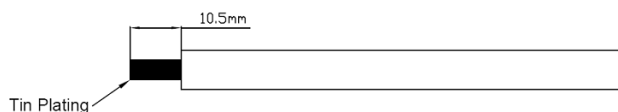

3. Pull all wires into the wiring box. The Remote Temperature Sensor and Battery Sense wires can be inside the conduit with the power conductors. It is easier to pull RTS and Sense wires before the power cables.

WARNING: Risk of Damage

Be sure that the battery connection is made with correct polarity. Turn on the battery breaker/disconnect and measure the voltage on the open battery wires **BEFORE** connecting to the controller. Disconnect the battery breaker/disconnect before wiring

to the controller.

4. Connect positive terminal (+) of battery to the battery positive terminal (+) on the controller.
5. Connect negative terminal (-) of battery to one of the Common Negative terminals (-) on the controller.

WARNING: Risk of Damage

Be sure that solar connection is made with correct polarity. Turn on the solar breaker/disconnect and measure the voltage on the open wires BEFORE connecting to the controller. Disconnect solar breaker/disconnect before wiring to the controller.

6. Connect positive wire (+) of solar module to the solar positive terminal (+) on the controller.
7. Connect negative wire (-) of solar module to one of the Common Negative terminals (-) on the controller.
8. Screw four (4) power terminals tightly with 50 in-lbs torque. (5.65 Nm)

3.5 Grounding and Ground Fault Interruption

Use a copper wire to connect the grounding terminal in the wiring box to earth ground. The grounding terminal is identified by the ground symbol shown below that is stamped into the wiring box just below the terminal:



The minimum size of the copper grounding wire is 8 AWG (10 mm²).

WARNING: Risk of Fire

DO NOT bond system electrical negative to earth ground at the controller.

3.6 Remote Temperature Sensor

The included Remote Temperature Sensor (RTS) is recommended for effective temperature compensated charging. Connect the RTS to the 2-pole terminal (see figure as below). The RTS is supplied with 33 ft (10 m) of 22 AWG (0.34 mm²) cable. There is no polarity, so either wire (+ or -) can be connected to either screw terminal.

The RTS cable may be pulled through conduit along with the power wires. Tighten the connector screws with 5 in-lb (0.56 Nm) torque.

NOTE: The RTS is optional package. Please check local dealer for the details.

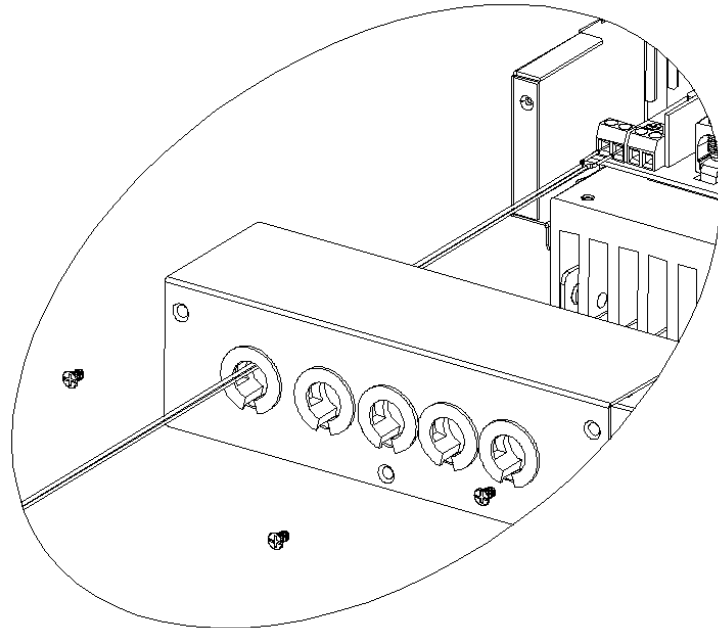

CAUTION: The controller will not activate temperature compensate charging function if the RTS is not used.

CAUTION: Equipment Damage

Never place the temperature sensor inside a battery cell. Both the RTS and the battery will be damaged.

NOTE: The RTS cable may be shortened if the full length is not needed.

3.7 Battery Voltage Sense

The voltage at the battery connection on the controller may differ slightly from the voltage directly at the battery bank terminals due to connection and cable resistance. The Battery Voltage Sense connection enables the controller to measure the battery terminal voltage precisely with small gauge wires that carry very little current, and thus have no voltage drop. Both battery voltage sense wires are connected to the 2-pole terminal inside of wiring box (see figure as below).

Be careful to connect the battery positive (+) terminal to the voltage sense positive (+) terminal and battery negative (-) terminal to the voltage sense negative terminal (-). No damage will occur if the polarity is reversed, but the controller cannot read a reversed sense voltage.

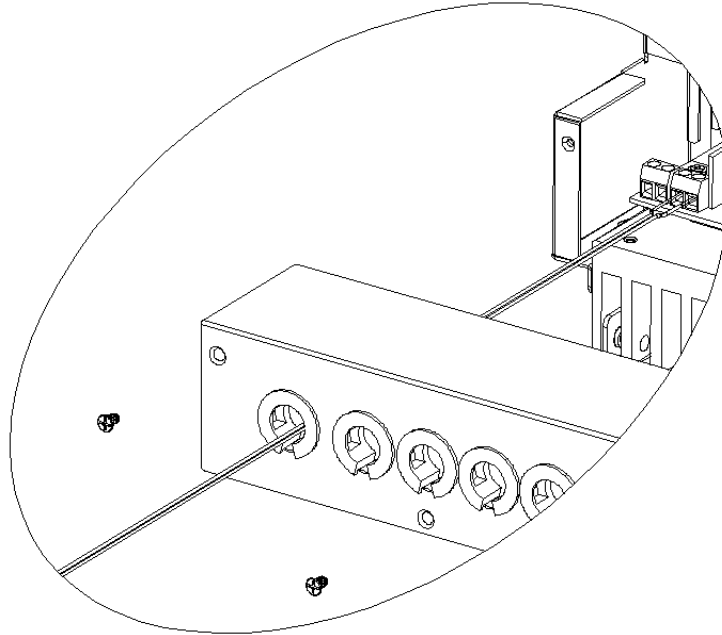

A battery voltage sense connection is not essential required to operate your controller, but it is recommended for best performance. The battery voltage sense will ensure that the voltage display in LCD is very accurate.

The voltage sense wires should be cut to length as required to connect the battery to the voltage sense terminal. The wire size can range from 16 to 24 AWG (1.0 to 0.25 mm²). A twisted pair cable is recommended but not required. Use UL rated 300 Volt conductors. The voltage sense wires may be pulled through conduit with the power conductors. Tighten the connector screws with 5 in-lb (0.56 Nm) torque.

The maximum length allowed for each battery voltage sense wire is 98 ft (30 m).

3.8 Communication Connections

The default communication of the controller is RS232 port. You can use supplied cable to connect RS-232 port of the controller to PC. It can be used for monitoring or upgrade the firmware in short distance.

Intelligent slot allows the controller to use different communication methods except RS232. Slot can support SNMP, USB, MODBUS cards and so on.

You can follow the below figure to install the card if you had purchased for it.

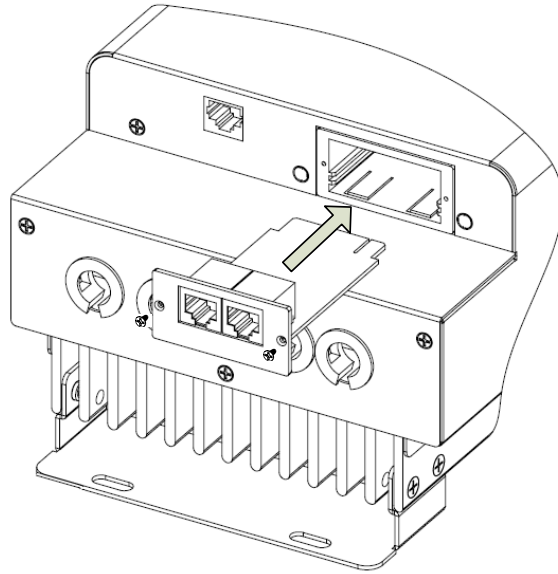

Insert bundled software CD into a computer and follow on-screen instruction to install the monitoring software. For the detailed software operation, please check user manual of software inside of CD.

4. OPERATION

4.1 Power-Up

WARNING: Risk of Damage

Connecting the solar module to the battery connector will permanently damage the controller.

- Confirm that the solar and battery polarities are correctly connected to the controller.
- A battery must be connected to the controller before operating it. The controller will not operate only with solar input. Solar input can trigger the controller to start up when the battery is connected without pressing the button.
- Turn on battery disconnect switch first. And press operation button for a while. Then, it will indicate a successful start-up in LCD display.
- Turn on solar disconnect switch. If the solar module is in full sunlight, the controller will begin charging.

4.2 Operation and Display Panel

The operation and display panel, shown in below chart, is on the front panel of the controller. It includes three indicators, one operation button and a LCD display, indicating the operating status and input/output power information.

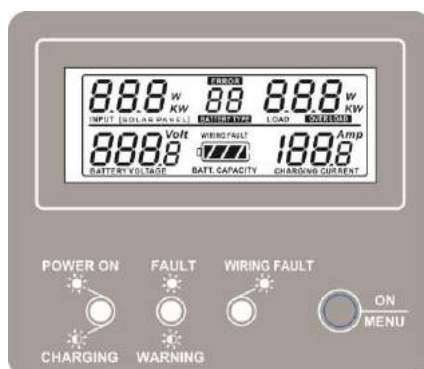

LED Indicator

LED Indicator		Messages	
POWER ON/ CHARGING	Green	Solid On	The controller is on.
		Flashing	The controller is charging. Bulk charge stage: flashing every 0.5 second Absorption stage: flashing every second Equalize stage: flashing every 3 seconds Float stage: flashing every 5 seconds
FAULT/ WARNING	Red	Solid On	Fault occurs.
		Flashing	Warning situation occurs.
WIRING FAULT	Red	Solid On	Battery polarities are not connected correctly.



Button Operation

Function	Action Description
Power on	Press the button until LCD backlight is on.
Backlight on	Press shortly
Enter LCD setting mode	Press the button for 3 seconds.
Select LCD setting programs or modify parameter	Press shortly.
Confirm selection in setting programs or return back to previous menu	Press the button for 1.5 seconds.

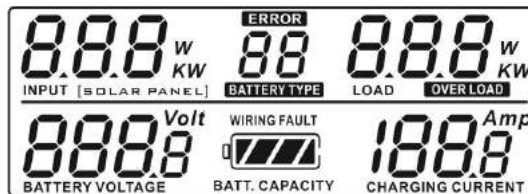
4.3 LCD Display Icons







Icon	Function description
Input Source Information	
	Indicates the PV input voltage.
Configuration Program and Fault Information	
	Indicates battery equalization is activated.
	Indicates fault codes.
	Indicates warning codes.
Output Information	
	Indicate battery voltage.
	Indicate charging power.

	Indicate charging current.															
	Indicates battery level by 0-24%, 25-49%, 50-74% and 75-100% in battery mode and charging status in line mode.															
Battery Charging Status.																
<table border="1"> <tr> <th>Status</th> <th>Battery voltage</th> <th>LCD Display</th> </tr> <tr> <td rowspan="4">Constant Current mode / Constant Voltage mode</td> <td><2V/cell</td> <td>4 bars will flash in turns.</td> </tr> <tr> <td>2 ~ 2.083V/cell</td> <td>The right bar will be on and the other three bars will flash in turns.</td> </tr> <tr> <td>2.083 ~ 2.167V/cell</td> <td>The two right bars will be on and the other two bars will flash in turns.</td> </tr> <tr> <td>> 2.167 V/cell</td> <td>The three right bars will be on and the left bar will flash.</td> </tr> <tr> <td>Floating mode</td> <td>Batteries are fully charged.</td> <td>4 bars will be on.</td> </tr> </table>	Status	Battery voltage	LCD Display	Constant Current mode / Constant Voltage mode	<2V/cell	4 bars will flash in turns.	2 ~ 2.083V/cell	The right bar will be on and the other three bars will flash in turns.	2.083 ~ 2.167V/cell	The two right bars will be on and the other two bars will flash in turns.	> 2.167 V/cell	The three right bars will be on and the left bar will flash.	Floating mode	Batteries are fully charged.	4 bars will be on.	
Status	Battery voltage	LCD Display														
Constant Current mode / Constant Voltage mode	<2V/cell	4 bars will flash in turns.														
	2 ~ 2.083V/cell	The right bar will be on and the other three bars will flash in turns.														
	2.083 ~ 2.167V/cell	The two right bars will be on and the other two bars will flash in turns.														
	> 2.167 V/cell	The three right bars will be on and the left bar will flash.														
Floating mode	Batteries are fully charged.	4 bars will be on.														

4.4 LCD setting

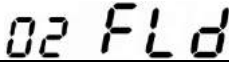

After pressing button for 3 seconds, the unit will enter setting mode. Shortly press button to select setting programs. And then, pressing button for at least 1.5 seconds to confirm the selected program. After that, shortly press button to modify the parameter of the program. If pressing button for at least 1.5 seconds, you will return to previous menu. After waiting for 10 seconds without any action, it will automatically exit setting mode.

Setting Programs:

Program	Description	Options
00	Exit setting mode	Escape 
01	Maximum charging current	60A (Default)  Setting range is from 10A to 60A. Increment of each short press is 1A. The value will be back to 10A once the value is achieved 60A.
02	Battery type	AGM(Default)  Flooded 
		Use-Defined  If "Use-Defined" is selected, battery charge voltage can be set up in program 3 and 4.

Program	Description	Options	
03	Absorption voltage	14.10V (Default) 03 14.1	If "Use-Defined" is selected in program 02, this program can be set up. The setting range is from 12.00V to 15.00V.
		If this program is selected to modify, the changeable figure will be shown as below. 03 4.10	Increment of each short press is 0.01. Once the value is achieved 15.00V, the value will jump back to 12.00V.
04	Float voltage	13.5V (Default) 04 13.5	If "Use-Defined" is selected in program 02, this program can be set up. The setting range is from 12.00V to 15.00V.
		If this program is selected to modify, the changeable figure will be shown as below. 04 3.50	Increment of each short press is 0.01V. The value will jump back to 12.00V after 15.00V is achieved.
05	Battery rated voltage	Auto (Default) 05 AU0	If "AU0" is selected, connected battery voltage system will be automatically detected.
		12V 05 12V	If "12V" is selected, the unit is considered as 12V battery system.
		24V 05 24V	If "24V" is selected, the unit is considered as 24V battery system.
		48V 05 48V	If "48V" is selected, the unit is considered as 48V battery system.
06	Battery C.V. charging duration	150 minutes (Default) 06 150	The setting range is from 5 minutes to 900 minutes. Increment of each short press is 5 minutes. It will jump back to 5minutes after 900 is achieved.

Program	Description	Options	
07	BTS temperature compensation ratio	0mV (Default) 07 00	The setting range is from 0mV to 60.0mV. Increment of each short press is 0.1 mV. The value will jump back to 0mV after 60.0mV is achieved. For each 12V battery, the derated battery charging voltage is followed the below formula: (Battery temperature – 25°C) * BTS ratio.
08	Battery equalization enable/disable	Disable (Default) 08 E9d	Enable 08 E9E
09	Battery equalization voltage	14.60V(Default) 09 146	The setting range is from 12.00V to 15.50V.
		If this program is selected to modify, the changeable figure will be shown as below. 09 460	Increment of each short press is 0.01V. The value will jump back to 12.00V after 15.50V is achieved.
10	The maximum current of battery equalization	15A (Default) 10 15A	The setting range is from 5A to 60A. Increment of each short press is 1A. The value will jump back to 5A after 60A is achieved.
11	Battery equalized time	60 minutes (Default) 11 60	The setting range is from 5 minutes to 900 minutes. Increment of each short press is 5 minutes. The value will jump back to 5 minutes after 900 minutes are achieved. .
12	Battery equalized timeout	120 minutes (Default) 12 120	The setting range is from 5 minutes to 900 minutes. Increment of each short press is 5 minutes. The value will jump back to 5 minutes after 900 minutes are achieved.
13	Equalization interval	30 days (Default) 13 30d	The setting range is from 0 day to 90 days.

Program	Description	Options	
14	Equalization activated immediately	Disable (Default)  Enable 	If equalization function is enabled in program 08, this program can be set up. If "Enable" is selected in this program, it's to activate battery equalization immediately and LCD main page will shows "E9". If "Disable" is selected, it will cancel equalization function until next activated equalization time arrives based on program 13 setting. At this time, "E9" will not be shown in LCD main page.

4.5 Reference Code

Type	Code	Event
Fault	01	Over charge current
	02	Over temperature
	03	Battery voltage is too low
	04	Battery voltage is high
	05	PV is high loss
	06	Battery temperature is too low
	07	Battery temperature is too high
Warning	20	PV is low loss
	21	Output derating caused from high PV voltage
	22	Output derating caused from high temperature
	23	Low alarm for battery temperature

5. CHARGING LOGIC

5.1 3-stage Charging

In general, this solar charge controller is designed with 3-stage battery charging algorithm for fast, efficient, and safe battery charging. The following picture shows the sequence of charging stages.

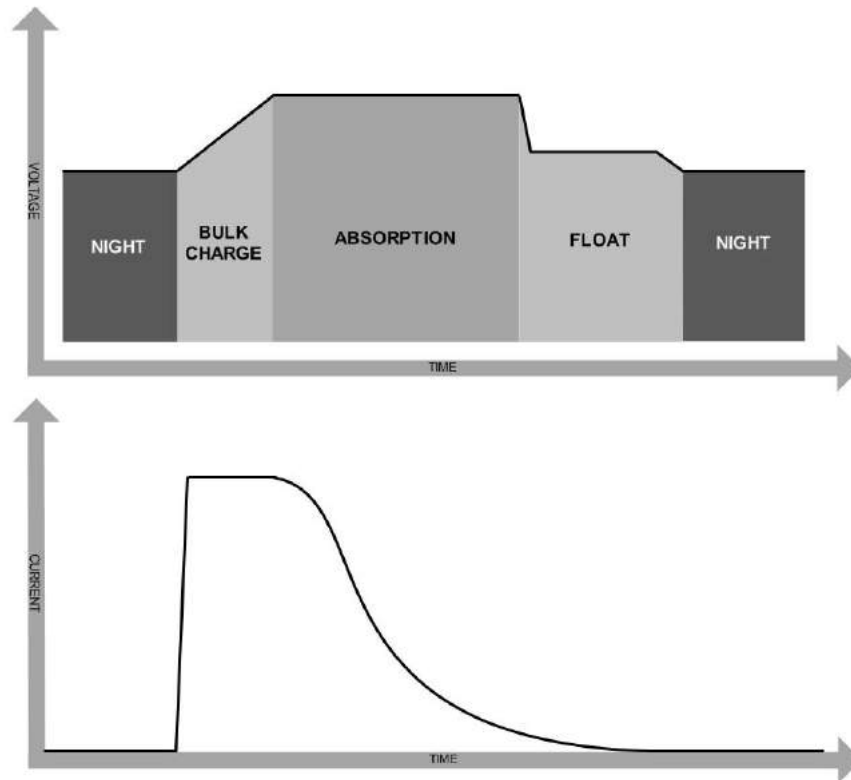

1) Bulk charge stage

In bulk charge stage, charge current begins to flow, typically at the maximum rate of the charge source. The controller will supply solar power to charge battery as much as possible.

2) Absorption stage

When battery charging voltage is reached to Absorption voltage point, the charging stage changes from bulk charge to Absorption. Constant-voltage regulation is used to maintain battery voltage at the Absorption stage.

If the charging current drops to one-tenth of the maximum charging current setting point, the charging status will change to Float stage.

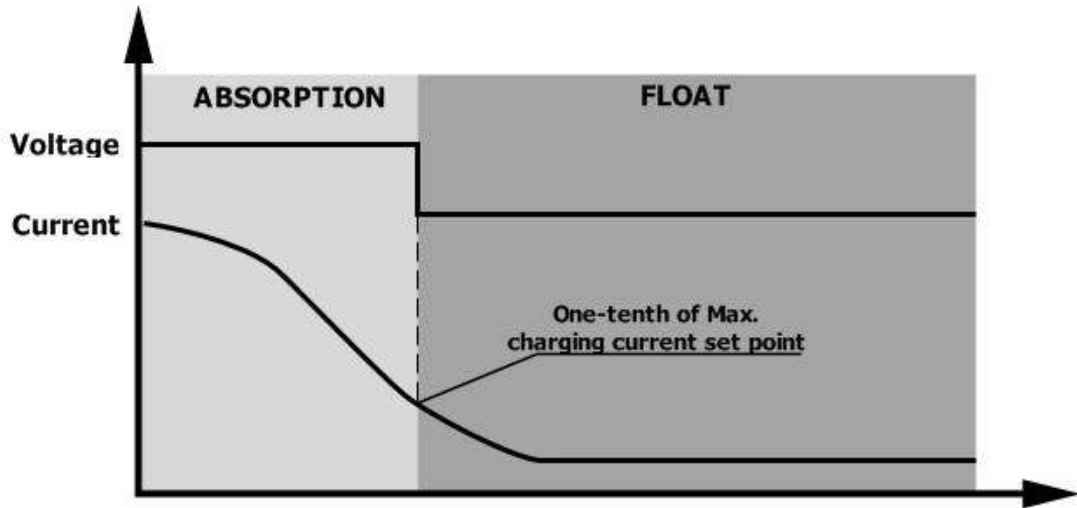

If the elapsed time of absorption stage is over setting value for C-V charging time, it will also transfer to Float stage.

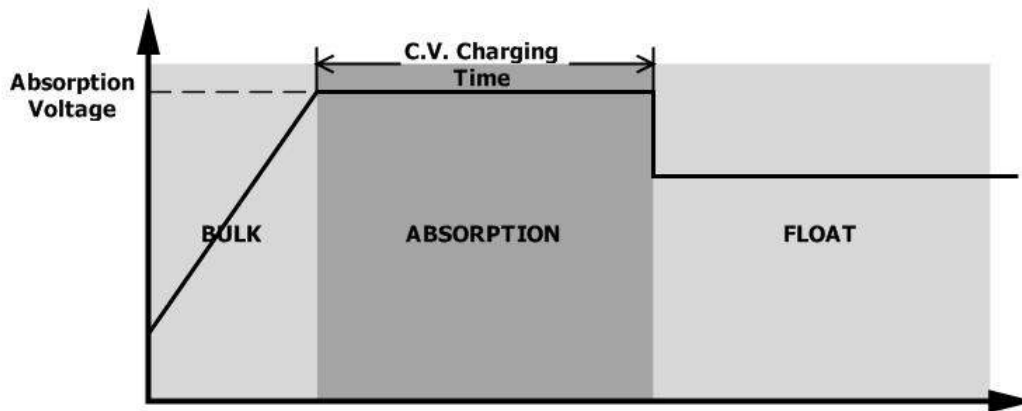

3) Float Stage

After the battery is fully charged in the Absorption stage, the controller will reduce the battery voltage to the setting point of Float voltage.

Once in Float stage, constant-voltage regulation is used to maintain battery voltage at setting point of float voltage.

- **Float timeout**

If the battery voltage remains lower than the Float voltage for 30 minutes, the controller will return to Bulk charging stage.

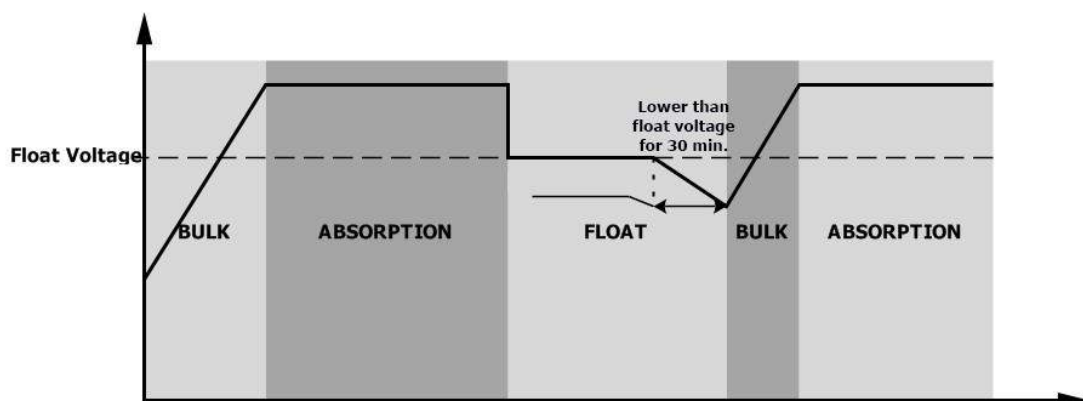

- **Float cancel voltage**

Once the battery voltage drops to setting point of Float cancel voltage, the controller also returns to Bulk charging stage.

Float cancel voltage = Floating charging voltage – (1V x battery numbers in series)

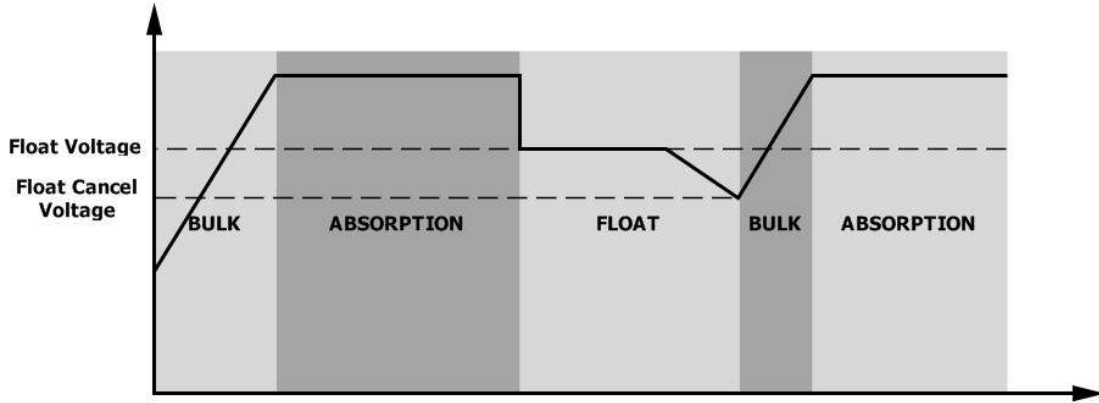

5.2 Equalize Stage

Equalization function is added into solar charge controller. It reverses the buildup of negative chemical effects like stratification, a condition where acid concentration is greater at the bottom of the battery than at the top. Equalization also helps to remove sulfate crystals that might have built up on the plates. If left unchecked, this condition, called sulfation, will reduce the overall capacity of the battery. Therefore, it's recommended to equalize battery periodically.

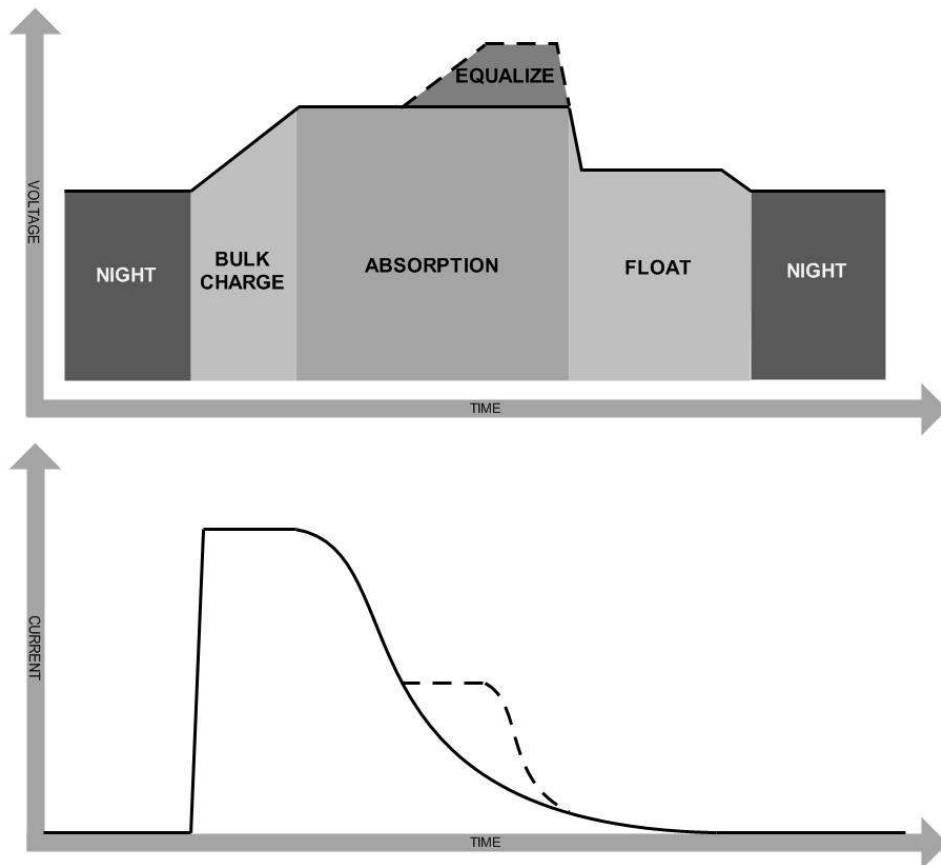

- **How to Apply Equalization Function**

You must enable battery equalization function in monitoring software first.

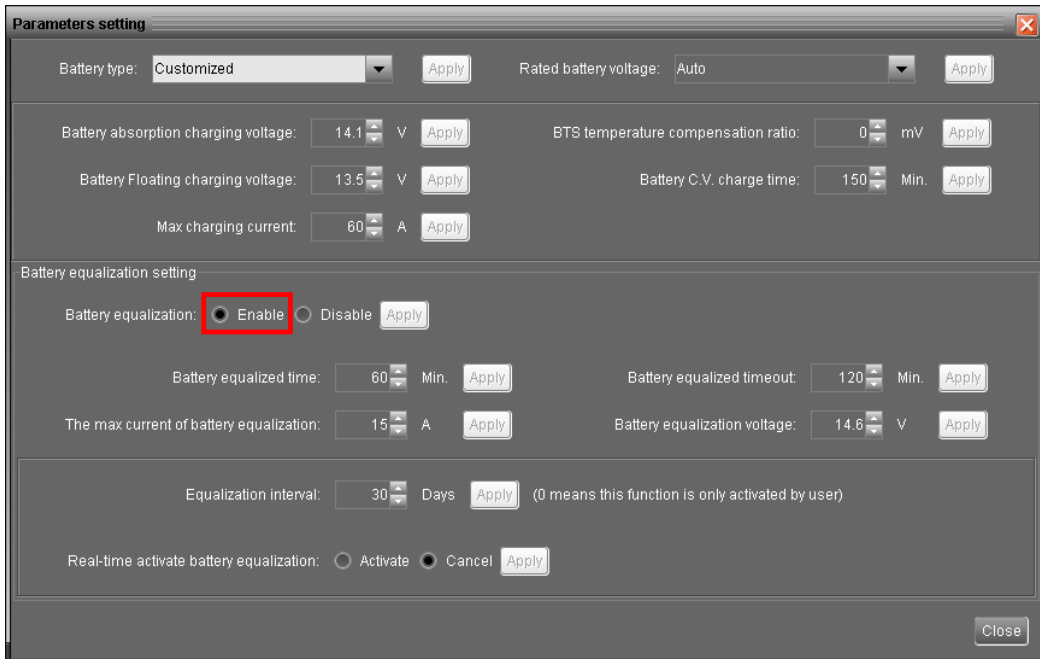

Then, you may apply this function in device by either one of following methods:

1. Setting equalization interval.
2. Or, press the button for 3 seconds until LCD shows "E9".

- **When to Equalize**

In Absorption stage, if the charging current drops lower than the maximum charging current of battery equalization, the controller will start to enter Equalize stage.

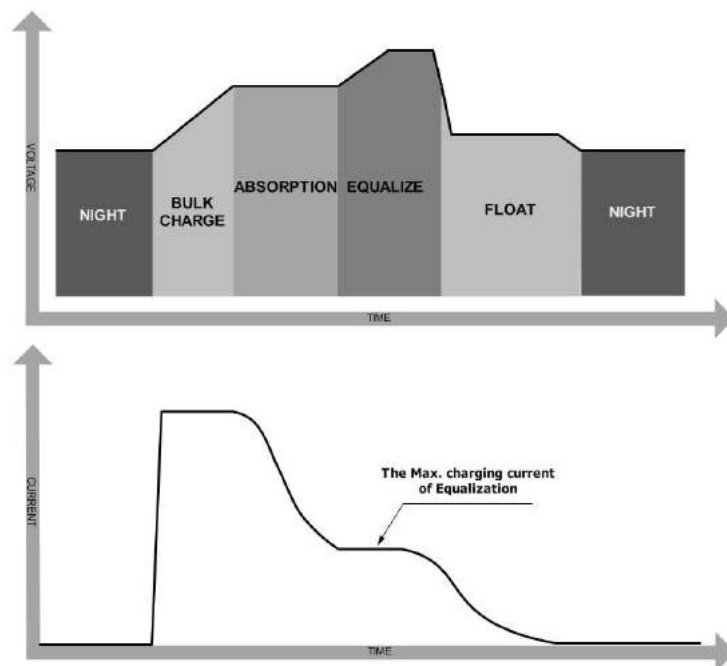

If solar charge controller is working in float stage, but at this time, the setting equalization interval (battery equalization cycle) is arrived, it will transfer to equalize stage.

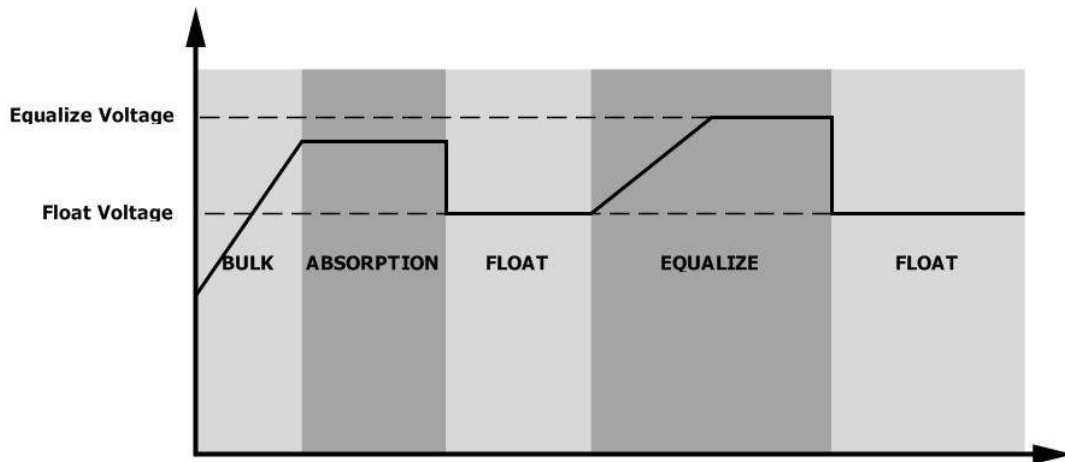

● **Equalize charging time and timeout**

In Equalize stage, based on maximum charging current of battery equalization, the controller will supply solar power to charge battery as much as possible until battery voltage raises to battery equalization voltage. Then, constant-voltage regulation is applied to maintain battery voltage at the battery equalization voltage.

The battery will remain in the Equalize stage until setting battery equalized time is arrived.

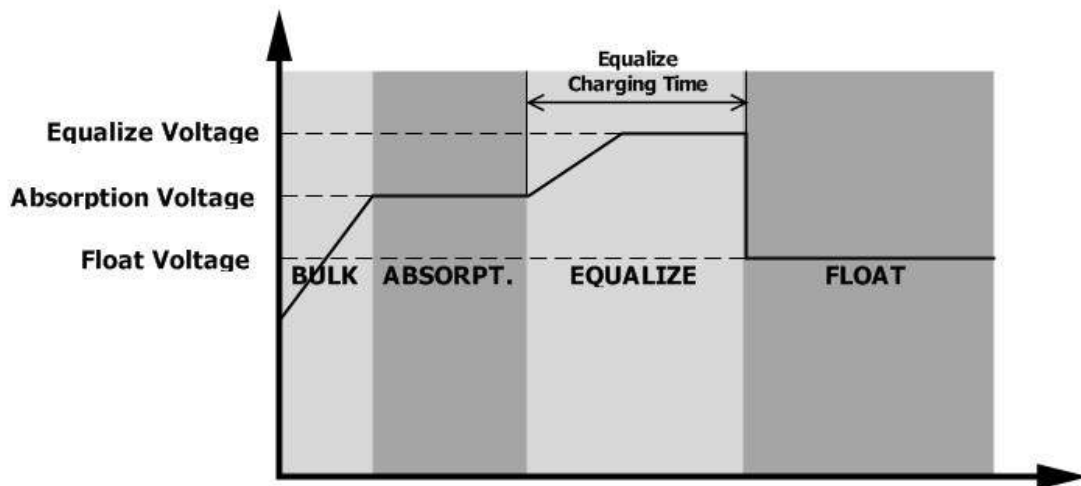

However, in Equalize stage, when battery equalized time is expired and battery voltage doesn't rise to battery equalization voltage point, the solar charge controller will extend the battery equalized time until battery voltage achieves battery equalization voltage. If battery voltage is still lower than battery equalization voltage when battery equalized timeout setting is over, the solar charge control will stop equalization and transfer to float stage.

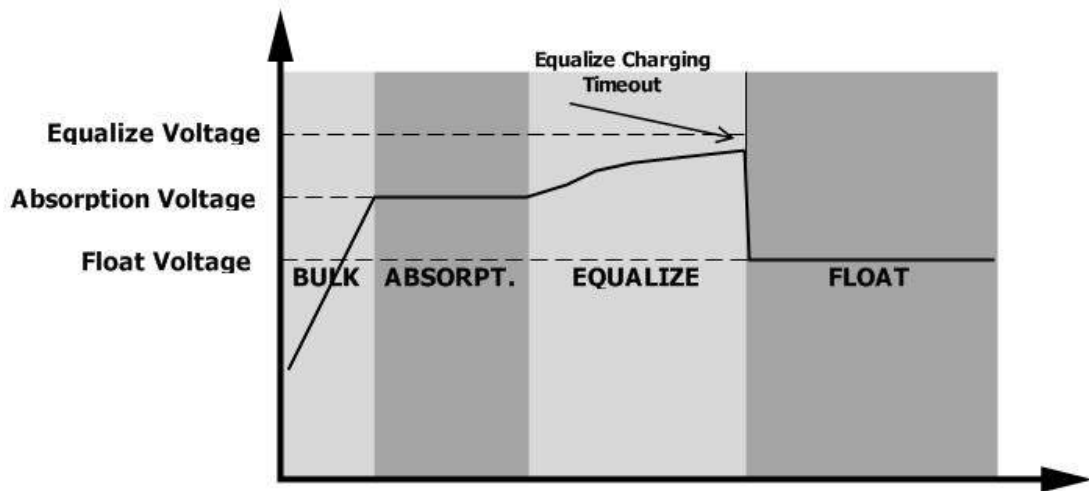

5.3 Setting Parameter and Default Value

Recommended and default parameter settings are listed below.

Parameter	Battery type	Absorp. Stage	Float Stage	Equalize Stage	Equalize Activation	Absorp. Time	Equalize Time	Equalize Timeout	Equalize Interval
Unit	-	Volt	Volt	Volt	En/Disable	Minutes	Minutes	Minutes	Days
Default	AGM	14.10	13.50	14.60	Disable	150	60	120	30
Option	Flooded	14.60	13.50	14.60	Disable	150	60	120	30
Option	Customized	-	-	-	Disable	150	60	120	30

6. PARALLEL CHARGING FUNCTION

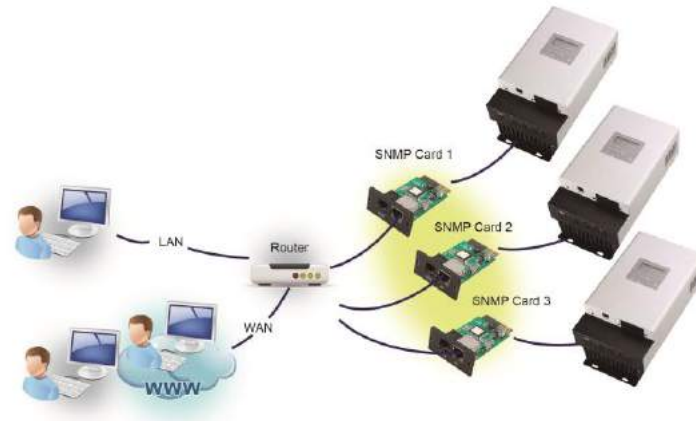

This function is only applied to use "MPPTTracker" software to control multiple chargers with Modbus or SNMP interface at the same time. Users can assign chargers in different groups. Refer to below chart for software setting screen. Chargers assigned in the same group will be parallel charged to the same batteries. After assignment, simply click "Enable" or "Disable" to activate parallel charging function. You can check more details from "MPPTTracker" user manual.

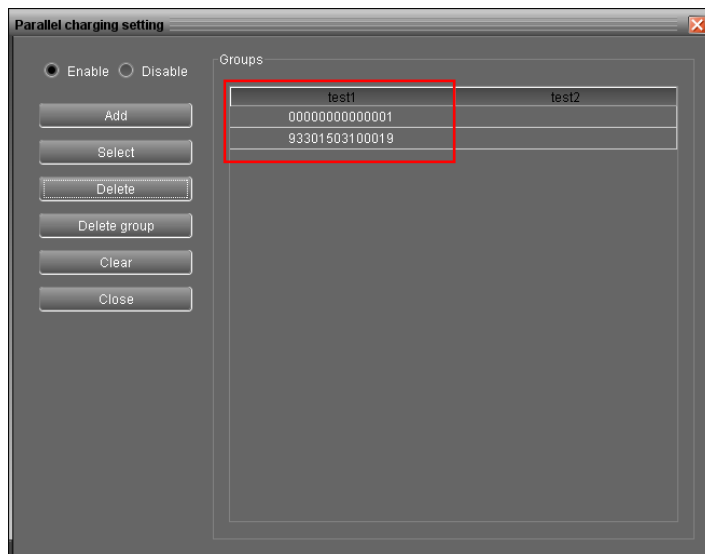

● Setting conditions

1. Computer setting

It's necessary to use computer running "MPPTTracker" software to synchronize actions of all chargers.

2. Equipped with Modbus or SNMP communication

Each charger must be connected with Modbus or SNMP card to have communication with computer.

3. Each charger should be connected to solar panel separately.

4. Chargers assigned in the same group should charge the same battery.

7. TROUBLE SHOOTING

Situation		Solution
Fault Code	Fault Event	
01	Over charge current	<ol style="list-style-type: none"> 1. Restart the charger. 2. If the problem remains, please contact your installer.
02	Over temperature	<ol style="list-style-type: none"> 1. Keep the charger in the cool environment. 2. If the problem remains, please contact your installer.
03	Battery voltage under	<ol style="list-style-type: none"> 1. Check the battery wire connection. 2. If the wire connection is ok, please contact your installer.
04	Battery voltage high	<ol style="list-style-type: none"> 1. Reconnect the battery to the charger. 2. If the problem remains, please contact your installer.
05	PV high loss	<ol style="list-style-type: none"> 1. Please check the voltage of the solar panel, it should be less than 140V. 2. If the voltage is ok, please contact your installer.
06	Battery temperature too low	<ol style="list-style-type: none"> 1. Check your remote temperature sensor and your battery ambient temperature. 2. If the problem remains, please contact your installer.
07	Battery temperature too high	<ol style="list-style-type: none"> 1. Check your remote temperature sensor and your battery ambient temperature. 2. If the problem remains, please contact your installer.
No display in LCD screen.		<ol style="list-style-type: none"> 1. Check battery wire connection. 2. Push the button, if the problem remains, please contact your installer.

8. SPECIFICATIONS

Table 1 Electrical Specifications

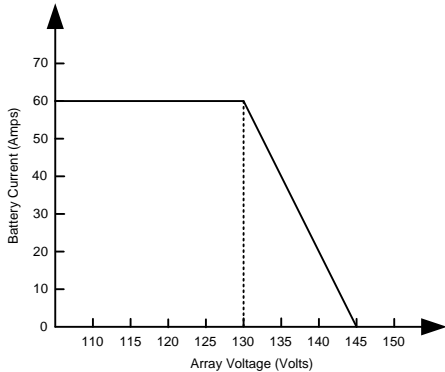
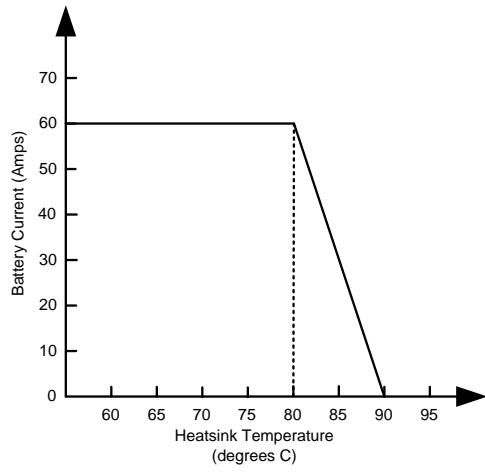
MODEL	MPPT 3KW
Nominal System Voltage	12, 24, or 48 VDC (Auto detection)
Maximum Battery Current	60 Amps
Maximum Solar Input Voltage	145V
PV Array MPPT Voltage Range	60~115VDC
Maximum Input Power	12 Volt--800 Watts 24 Volt--1600 Watts 48 Volt--3200 Watts
PV Array voltage & Battery current	 <p>The graph plots Battery Current (Amps) on the y-axis (0 to 70) against Array Voltage (Volts) on the x-axis (110 to 150). The current remains constant at 60A until the array voltage reaches 130V. Beyond 130V, the current decreases linearly, reaching 0A at 145V.</p>
Heatsink temperature & Battery current	 <p>The graph plots Battery Current (Amps) on the y-axis (0 to 70) against Heatsink Temperature (degrees C) on the x-axis (60 to 95). The current remains constant at 60A until the temperature reaches 80°C. Beyond 80°C, the current decreases linearly, reaching 0A at 90°C.</p>
Transient Surge Protection	4500 Watts / port

Protections	Solar high voltage disconnect Solar high voltage reconnect Battery high voltage disconnect Battery high voltage reconnect High temperature disconnect High temperature reconnect
--------------------	---

Table 2 Battery Charging

MODEL	MPPT 3K	
Charging Algorithm	3-Step	
Charging stages	Bulk, Absorption, Float	
Temperature compensation coefficient	-5 mV / °C / cell (25 °C ref.)	
Temperature compensation range	25°C to +50 °C	
Temperature compensated set points	Absorption, Float	
Charging Set points	Absorption Stage	Float Stage
Flooded Battery	14.6V / 29.2V / 58.4V	13.5V / 27V / 54V
AGM/Gel Battery (Default)	14.1V / 28.2V / 56.4V	13.5V / 27V / 54V
Over-charging voltage	15V / 30V / 60V	
Over-charging comeback voltage	14.5V / 29V / 58V	
Battery defect voltage	8.5V / 17V / 34V	
Battery defect comeback voltage	9V / 18V / 36V	

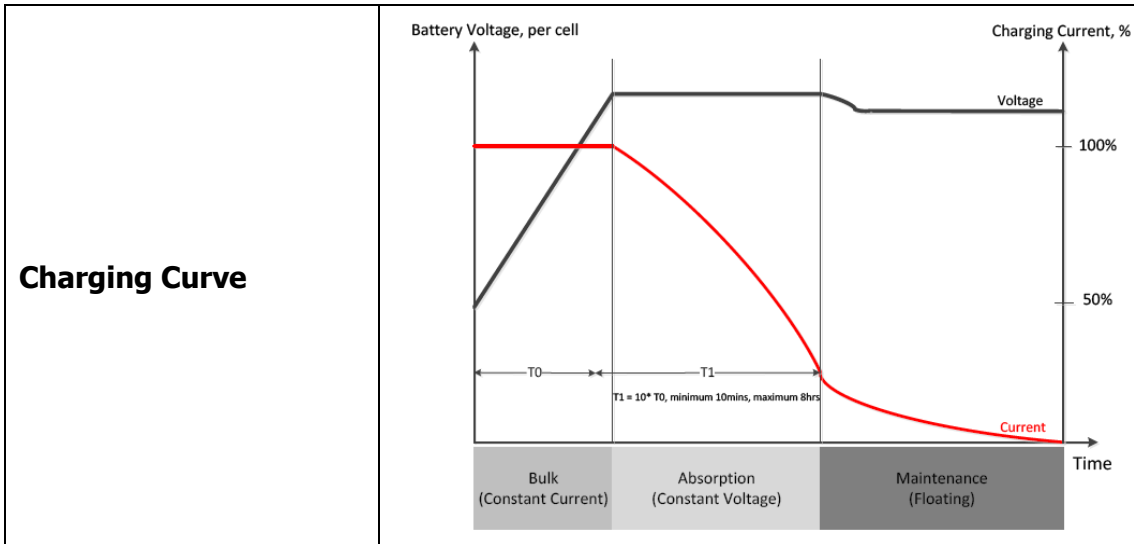

Table 3 Mechanical and Environment

Charger MODEL	MPPT 3K
Product size (W x H x D, mm)	315 x 165 x 128
Product weight (Kg)	4.5
Ambient Temperature Range	0°C to 55°C
Storage Temperature	-40°C to 75°C
Humidity	0%-90% RH(No condensing)
Enclosure	IP31 (indoor & vented)